

# JVC

## SERVICE MANUAL

### CD/CASSETTE RECEIVER

# KW-TC410, KW-TC411

Area suffix

UN ----- Indonesia

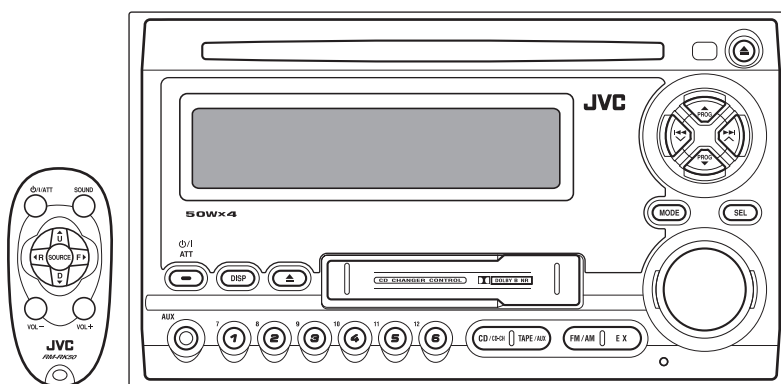

Lead free solder used in the board (material : Sn-Ag-Cu, melting point : 219 Centigrade)

### TABLE OF CONTENTS

1	PRECAUTIONS .....	1-3
2	SPECIFIC SERVICE INSTRUCTIONS .....	1-6
3	DISASSEMBLY .....	1-7
4	ADJUSTMENT .....	1-13
5	TROUBLESHOOTING .....	1-16

# SPECIFICATION

<b>AUDIO AMPLIFIER SECTION</b>		
Maximum Power Output	Front	50 W per channel
	Rear	50 W per channel
Continuous Power Output (RMS)	Front	19 W per channel into 4 $\Omega$ , 40 Hz to 20 000 Hz at no more than 0.8% total harmonic distortion.
	Rear	19 W per channel into 4 $\Omega$ , 40 Hz to 20 000 Hz at no more than 0.8% total harmonic distortion.
Load Impedance	4 $\Omega$ (4 $\Omega$ to 8 $\Omega$ allowance)	
Equalizer Control Range	Low	$\pm 12$ dB (60 Hz, 80 Hz, 100 Hz, 120 Hz)
	Mid	$\pm 12$ dB
	High	$\pm 12$ dB (8 kHz, 10 kHz, 12 kHz, 15 kHz)
Frequency Response	40 Hz to 20 000 Hz	
Signal-to-Noise Ratio	70 dB	
Line-Out Level/Impedance	2.0 V/20 k $\Omega$ load (full scale)	
Output Impedance	1 k $\Omega$	
Other terminals	CD changer, AUX (auxiliary) input jack	
<b>TUNER SECTION</b>		
Frequency Range	FM	87.5 MHz to 108.0 MHz
	AM	531 kHz to 1 602 kHz
[FM Tuner]	Usable Sensitivity	11.3 dBf (1.0 $\mu$ V/75 $\Omega$ )
	50 dB Quieting Sensitivity	16.3 dBf (1.8 $\mu$ V/75 $\Omega$ )
	Alternate Channel Selectivity (400 kHz)	65 dB
	Frequency Response	40 Hz to 15 000 Hz
	Stereo Separation	30 dB
	Capture Ratio	1.5 dB
[AM Tuner]	Sensitivity	20 $\mu$ V
	Selectivity	35 dB
<b>CD PLAYER SECTION</b>		
Type	Compact disc player	
Signal Detection System	Non-contact optical pickup (semiconductor laser)	
Number of Channels	2 channels (stereo)	
Frequency Response	5 Hz to 20 000 Hz	
Dynamic Range	96 dB	
Signal-to-Noise Ratio	98 dB	
Wow and Flutter	Less than measurable limit	
MP3 Decoding Format (KW-TC411/KW-TC410 only)	MPEG1/2 Audio Layer 3 Max. Bit Rate: 320 kbps	
WMA (Windows Media® Audio) Decoding Format (KW-TC411/KW-TC410 only)	Max. Bit Rate: 192 kbps	
<b>CASSETTE DECK SECTION</b>		
Wow and Flutter	0.1 % (WRMS)	
Fast-Wind Time	100 sec. (C-60)	
Frequency Response	30 Hz to 16 000 Hz (Normal tape)	
Signal-to-Noise Ratio (Normal tape)	Dolby B NR ON	65 dB
	Dolby B NR OFF	56 dB
	Stereo Separation	40 dB
<b>GENERAL</b>		
Power Requirement	Operating Voltage	DC 14.4 V (11 V to 16 V allowance)
Grounding System:	Negative ground	
Allowable Operating Temperature	0°C to +40°C	
Dimensions (W $\times$ H $\times$ D)	Installation Size (approx.)	178 mm $\times$ 100 mm $\times$ 158 mm
	Set Size (approx.)	178 mm $\times$ 100 mm $\times$ 177 mm
	Mass (approx.)	2.3 kg (excluding accessories)

Design and specification are subject to change without notice.

# SECTION 1 PRECAUTIONS

## 1.1 Safety Precautions

 **CAUTION** Burrs formed during molding may be left over on some parts of the chassis. Therefore, pay attention to such burrs in the case of performing repair of this system.

 **CAUTION** Please use enough caution not to see the beam directly or touch it in case of an adjustment or operation check.

## 1.2 Preventing static electricity

Electrostatic discharge (ESD), which occurs when static electricity stored in the body, fabric, etc. is discharged, can destroy the laser diode in the traverse unit (optical pickup). Take care to prevent this when performing repairs.

### 1.2.1 Grounding to prevent damage by static electricity

Static electricity in the work area can destroy the optical pickup (laser diode) in devices such as CD players.

Be careful to use proper grounding in the area where repairs are being performed.

(1) Ground the workbench

Ground the workbench by laying conductive material (such as a conductive sheet) or an iron plate over it before placing the traverse unit (optical pickup) on it.

(2) Ground yourself

Use an anti-static wrist strap to release any static electricity built up in your body.

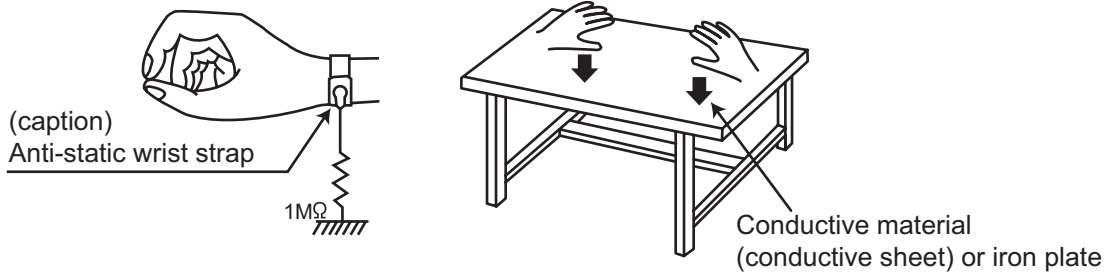

(3) Handling the optical pickup

- In order to maintain quality during transport and before installation, both sides of the laser diode on the replacement optical pickup are shorted. After replacement, return the shorted parts to their original condition. (Refer to the text.)
- Do not use a tester to check the condition of the laser diode in the optical pickup. The tester's internal power source can easily destroy the laser diode.

## 1.3 Handling the traverse unit (optical pickup)

- (1) Do not subject the traverse unit (optical pickup) to strong shocks, as it is a sensitive, complex unit.
- (2) Cut off the shorted part of the flexible cable using nippers, etc. after replacing the optical pickup. For specific details, refer to the replacement procedure in the text. Remove the anti-static pin when replacing the traverse unit. Be careful not to take too long a time when attaching it to the connector.
- (3) Handle the flexible cable carefully as it may break when subjected to strong force.
- (4) It is not possible to adjust the semi-fixed resistor that adjusts the laser power. Do not turn it.

## 1.4 Attention when traverse unit is decomposed

**\*Please refer to "Disassembly method" in the text for the CD pickup unit.**

- Apply solder to the short land before the flexible wire is disconnected from the connector on the CD pickup unit. (If the flexible wire is disconnected without applying solder, the CD pickup may be destroyed by static electricity.)
- In the assembly, be sure to remove solder from the short land after connecting the flexible wire.

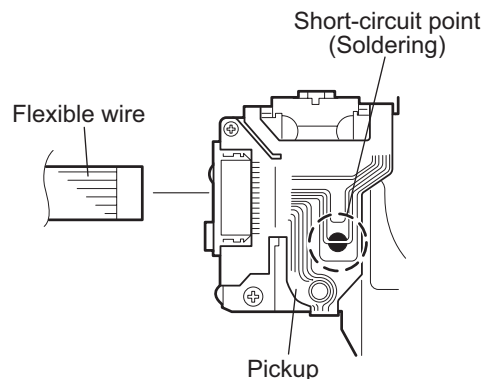

## 1.5 Important for laser products

### 1.CLASS 1 LASER PRODUCT

**2.DANGER** : Invisible laser radiation when open and interlock failed or defeated. Avoid direct exposure to beam.

**3.CAUTION** : There are no serviceable parts inside the Laser Unit. Do not disassemble the Laser Unit. Replace the complete Laser Unit if it malfunctions.

**4.CAUTION** : The CD,MD and DVD player uses invisible laser radiation and is equipped with safety switches which prevent emission of radiation when the drawer is open and the safety interlocks have failed or are defeated. It is dangerous to defeat the safety switches.

**5.CAUTION** : If safety switches malfunction, the laser is able to function.

**6.CAUTION** : Use of controls, adjustments or performance of procedures other than those specified here in may result in hazardous radiation exposure.

 **CAUTION** Please use enough caution not to see the beam directly or touch it in case of an adjustment or operation check.

**CAUTION** : Visible and invisible laser radiation when open and interlock failed or defeated.

AVOID DIRECT EXPOSURE TO BEAM.

**ADVARSEL** : Synlig og usynlig laserstråling når maskinen er åben eller interlocken fejler. Undgå direkte eksponering til stråling.

**VARNING** : Synlig och osynlig laserstråling när den öppnas och spärren är urkopplad. Betrakta ej strålen.

**VARO** : Avattaessa ja suojalukitus ohitettuna tai viallisena olet alltiina näkyvälle ja näkymättömälle lasersäteilylle. Vältä säteen kohdistumista suoraan itseesi.

## REPRODUCTION AND POSITION OF LABELS

### WARNING LABEL

CLASS 1  
LASER PRODUCT

**CAUTION** : Visible and invisible laser radiation when open and interlock failed or defeated. AVOID DIRECT EXPOSURE TO BEAM. (e)

**ADVARSEL** : Synlig og usynlig laserstråling når maskinen er åben eller interlocken fejler. Undgå direkte eksponering til stråling. (d)

**VARNING** : Synlig och osynlig laserstråling när den öppnas och spärren är urkopplad. Betrakta ej strålen. (s)

**VARO** : Avattaessa ja suojalukitus ohitettuna tai viallisena olet alltiina näkyvälle ja näkymättömälle lasersäteilylle. Vältä säteen kohdistumista suoraan itseesi. (f)

## **SECTION 2**

### **SPECIFIC SERVICE INSTRUCTIONS**

#### **2.1 CD mechanism and cassette mechanism**

For the CD mechanism, please refer the mechanism manual TN2001-1013 No.MY001.

For the Cassette mechanism, please refer the mechanism manual CDS-802JE3 No.MY002.

## SECTION 3 DISASSEMBLY

### 3.1 Main body section

#### 3.1.1 Removing the front panel assembly

(See Figs.1 and 2)

- (1) From the both side of the main body, remove the two screws **A** attaching the front panel assembly. (See Figs.1 and 2.)
- (2) Release the four joints **a** and remove the front panel assembly in the direction of the arrow. (See Figs.1 and 2.)

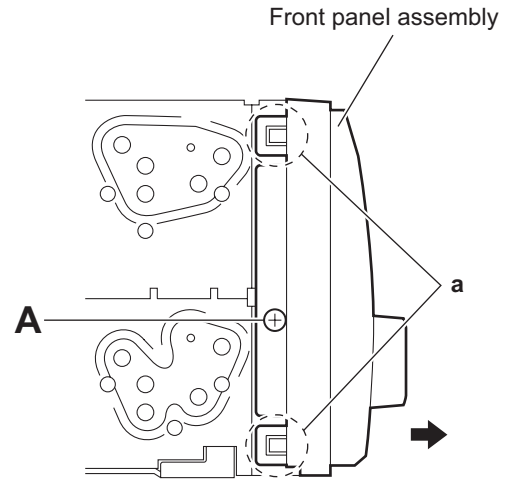

Fig.1

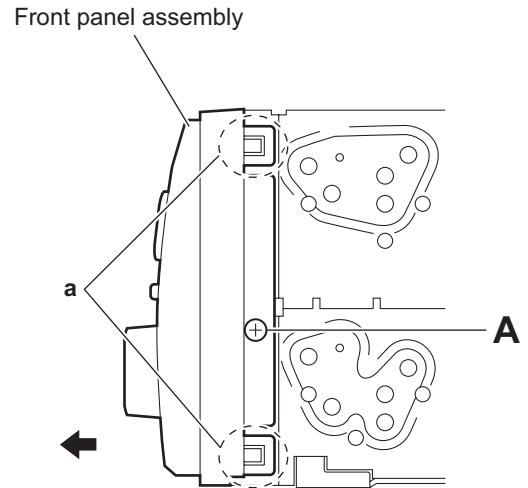

Fig.2

**3.1.2 Removing the heat sink**  
(See Figs.3 and 4)

- (1) From the back side of the main body, remove the six screws **B** attaching the heat sink. (See Fig.3.)
- (2) Remove the heat sink from the main body.

**Note:**

- Before attaching the heat sink, attach the cooling rubbers on the power amplifier IC. (See Fig.4)
- When attaching the heat sink, set the projections **b** on the rear bracket in the holes of the heat sink. (See Fig.3.)

**3.1.3 Removing the rear bracket**  
(See Fig.4)

- Remove the heat sink.

  - (1) From the back side of the main body, remove the six screws **C**, two screws **D** and screw **E** attaching the rear bracket.
  - (2) Remove the rear bracket from the main body.

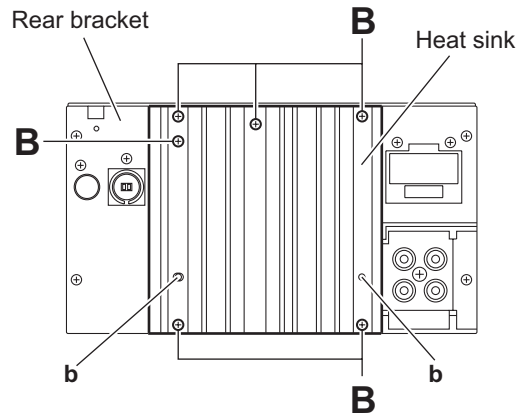

Fig.3

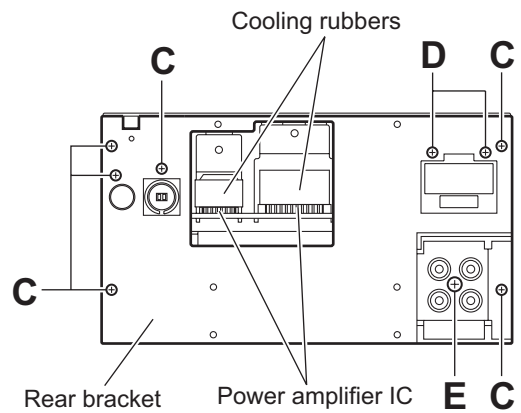

Fig.4

**3.1.4 Removing the bottom chassis assembly**  
(See Fig.5)

- Remove the front panel assembly, heat sink and rear bracket.

  - (1) From the bottom side of the main body, remove the four screws **F** attaching the bottom chassis assembly.
  - (2) Take out the bottom chassis assembly from the main body.

**Reference:**

When attaching the bottom chassis assembly, set the projections **c** of the main body in the holes of the bottom chassis assembly.

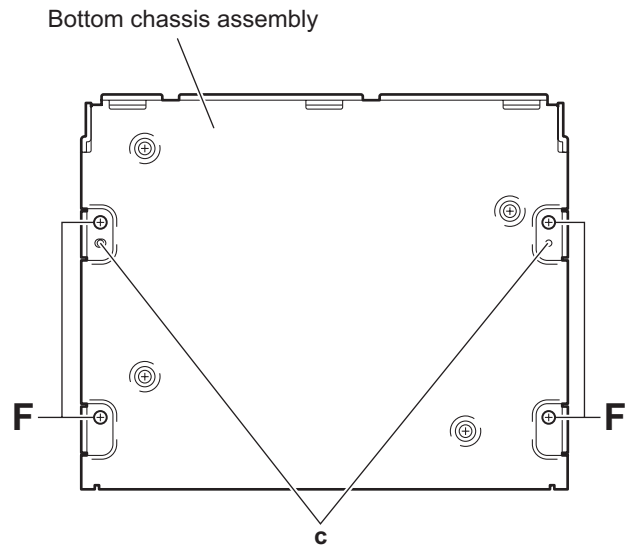

Fig.5



### 3.1.5 Removing the cassette mechanism control board (See Fig.6)

- Remove the front panel assembly, heat sink, rear bracket and bottom chassis assembly.
  - From the inside of the bottom chassis assembly, disconnect the card wire from the connector [CN403](#) on the cassette mechanism control board.
  - Disconnect the wire from the connector [CN402](#) on the cassette mechanism control board.
  - Remove the three screws **G** attaching the cassette mechanism control board.
  - Take out the cassette mechanism control board from the bottom chassis assembly.

#### Reference:

- When attaching the cassette mechanism control board, set the projections **d** of the bottom chassis assembly in the holes of the cassette mechanism control board.
- After attaching the cassette mechanism control board, fix the wire with the wire clamp as before.

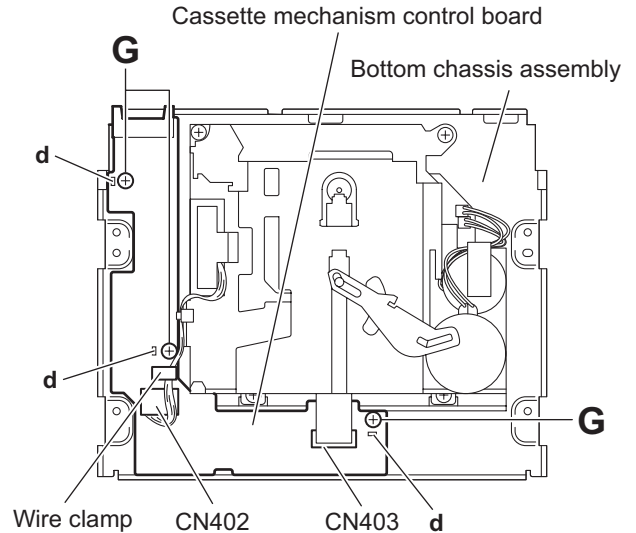

Fig.6

### 3.1.6 Removing the cassette mechanism assembly (See Fig.7)

- Remove the front panel assembly, heat sink, rear bracket and bottom chassis assembly.
  - From the inside of the bottom chassis assembly, disconnect the card wire from the connector [CN403](#) on the cassette mechanism control board.
  - Disconnect the wire from the connector [CN402](#) on the cassette mechanism control board.
  - Remove the four screws **H** attaching the cassette mechanism assembly.

#### Reference:

- After attaching the cassette mechanism control board, fix the wire with the wire clamp as before.

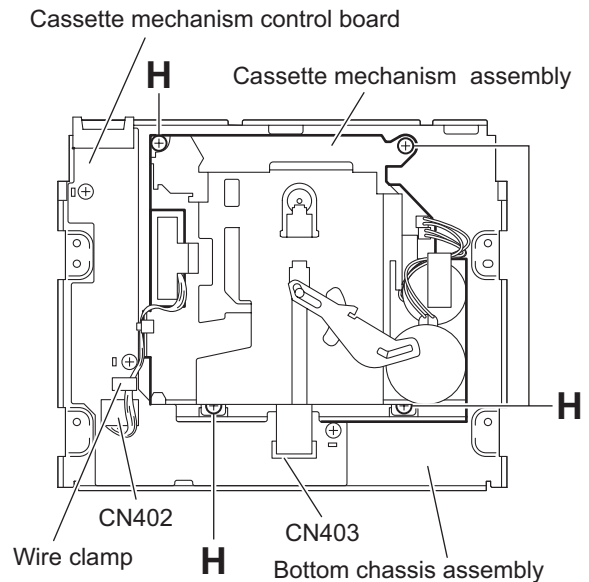

Fig.7

### 3.1.7 Removing the func board (See Fig.8)

- Remove the front panel assembly, heat sink, rear bracket and bottom chassis assembly.
  - From the bottom side of the main body, disconnect the wire from the connector [CN321](#) on the func board.
  - Remove the screw **J** and take out the func board from the main body.

### 3.1.8 Removing the middle chassis assembly (See Fig.8)

- Remove the front panel assembly, heat sink, rear bracket and bottom chassis assembly.
  - From the bottom side of the main body, remove the four screws **K** attaching the middle chassis assembly.
  - Disconnect the connector [CN705](#) of the main board on the middle chassis assembly from the CD mechanism assembly in an upward direction.

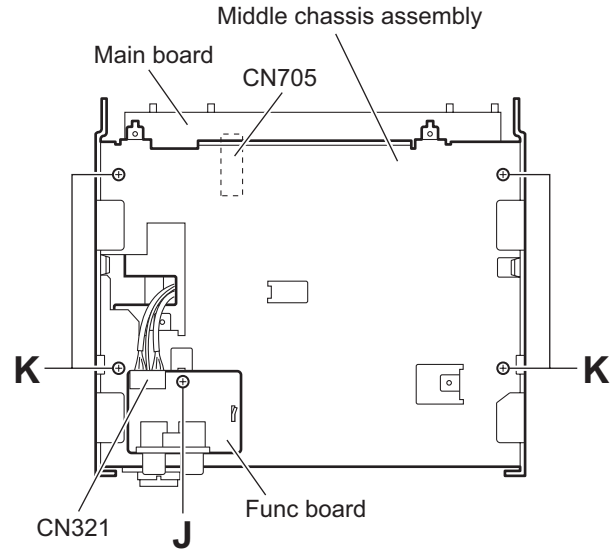

Fig.8

### 3.1.9 Removing the main board (See Fig.9)

- Remove the front panel assembly, heat sink, rear bracket, bottom chassis assembly and middle chassis assembly.
  - From the top side of the middle chassis assembly, disconnect the wire from the connector [CN323](#) on the main board.
  - Remove the four screws **M** attaching the main board on the middle chassis.
  - Remove the main board from the middle chassis.

#### Reference:

When attaching the main board, set the projections **e** of the middle chassis in the holes of the main board.

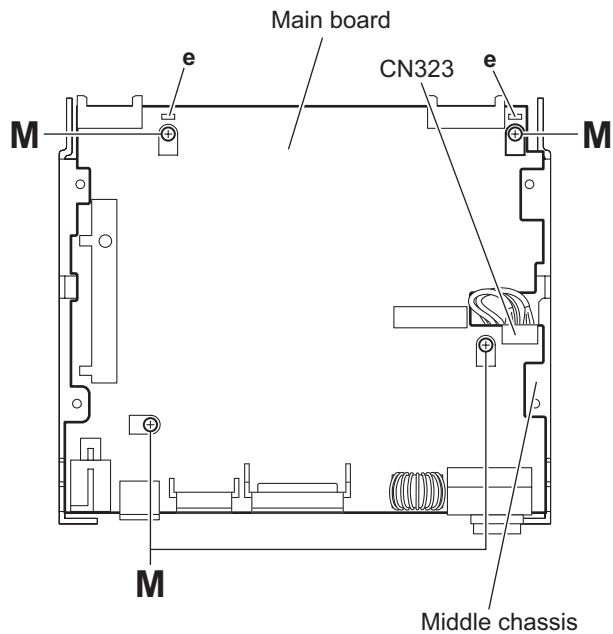

Fig.9

**3.1.10 Removing the CD mechanism control board**  
(See Fig.10)

- Remove the front panel assembly, heat sink, rear bracket, bottom chassis assembly and middle chassis assembly.
  - (1) From the inside of the top chassis assembly, disconnect the card wire from the connector [CN601](#) on the CD mechanism control board.
  - (2) Remove the five screws **N** attaching the CD mechanism control board.
  - (3) Lift the CD mechanism control board to remove the joint **f** and remove the joint **g** in the direction of the arrow.

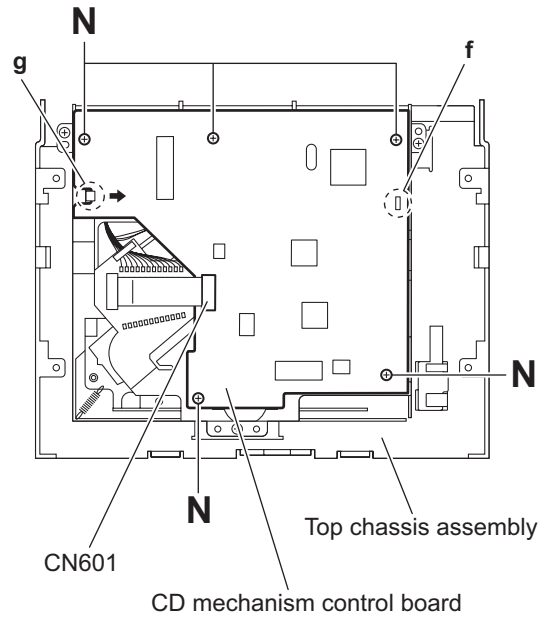

Fig.10

**3.1.11 Removing the CD mechanism assembly**  
(See Fig.11)

- Remove the front panel assembly, heat sink, rear bracket, bottom chassis assembly, middle chassis assembly and CD mechanism control board.
  - (1) From the inside of the top chassis assembly, remove the three screws **P** attaching the CD mechanism assembly.
  - (2) Take out the CD mechanism assembly from the top chassis.

**Reference:**

When attaching the CD mechanism assembly, set the projections **h** of the top chassis assembly in the holes of the CD mechanism assembly.

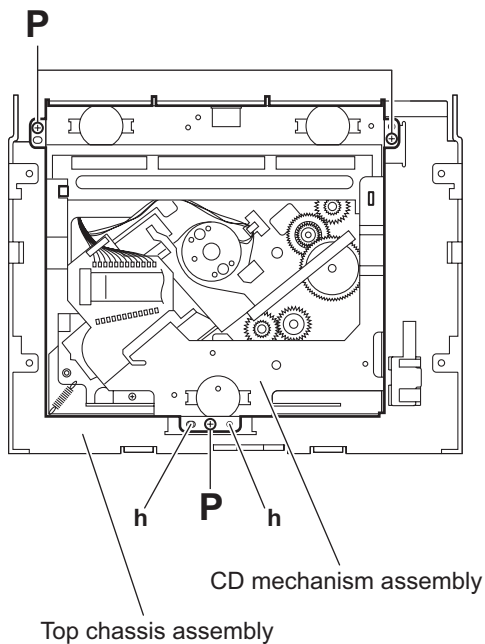

Fig.11

### 3.1.12 Removing the switch board (See Fig.12)

- Remove the front panel assembly.
  - From the inside of front panel assembly, remove the thirteen screws **Q** attaching the switch board.
  - Remove the volume knob from the front side of the front panel assembly in the direction of the arrow while lifting the switch board little by little.
  - Release the sections **j** while extending the lower section of the front panel assembly in the direction of the arrow and take out the switch board.

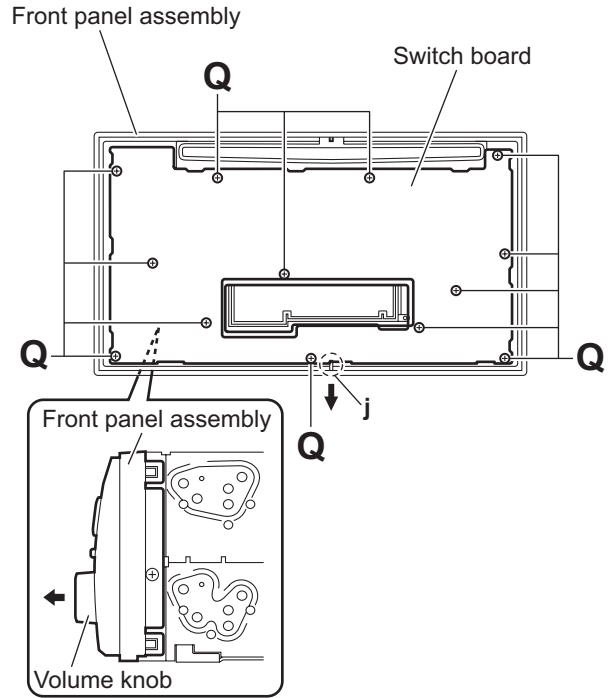

Fig.12

# SECTION 4 ADJUSTMENT

## 4.1 Adjustment method

### ■ Test instruments required for adjustment

- (1) Digital oscilloscope (100MHz)
- (2) Frequency counter meter
- (3) Electric voltmeter
- (4) Wow & flutter meter
- (5) Test tapes
  - VT724.....For DOLBY level measurement
  - VT739.....For playback frequency measurement
  - VT712.....For wow flutter & tape speed measurement
  - VT703.....For head azimuth measurement
- (6) Torque gauge.....Cassette type for CTG-N  
(Mechanism adjustment)
- (7) Laser power meter(Reader:LP800102)
- (8) Prove for MD (Reader:LP8010-02)
- (9) Pre masterd disc (TGYS-1)
- (10)Test disc (JVC:CTS1000)

### ■ Measuring conditions (Amplifier section)

- Power supply voltage..... DC14.4V (11V to 16V allowance)
- Load impedance..... 4Ω (4Ω to 8Ω allowance)
- Line out level/Impedance.....1.0V/20k load (250 nWb/m)

### ■ Standard volume position

Balance and Bass, Treble volume, Fader : Center (Indication "0")  
Loudness, Dolby NR, Sound, Cruise : Off  
Volume position is about 2V at speaker output with following conditions, Playback the test tape VT721.

AM mode	999kHz/62dB, INT/400Hz, 30% modulation signal on receiving.
FM mono mode	97.9MHz/66dB, INT/400Hz, 22.5kHz deviation pilot off mono
FM stereo mode	1kHz, 67.5kHz dev. pilot 7.5kHz dev.
Output level	0dB (1μV,50Ω/open terminal)

### ■ Information for using a car audio service jig

- (1) We're advancing efforts to make our extension cords common for all car audio products.  
Please use this type of extension cord as follows.
- (2) As a U-shape type top cover is employed, this type of extension cord is needed to check operation of the mechanism assembly after disassembly.
- (3) Extension cord : EXTSH002-22P ( 22 pin extension cord ) For connection between the mechanism assembly and main board.  
EXTXC004-20P ( 20 pin extension cord ) For connection between the front panel assembly and main board.  
EXTXC004-16P ( 16 pin extension cord ) For connection between the front panel assembly and main board.  
EXTXC004-16P ( 16 pin extension cord ) For connection between the front panel assembly and cassette mechanism assembly.
- (4) Check for mechanism driving section such as motor ,etc.

### ■ Disassembly method

- (1) Remove the front panel assembly.
- (2) Remove the heat sink.
- (3) Remove the rear bracket.
- (4) Remove the bottom chassis assembly and middle chassis assembly.
- (5) Remove the main board.
- (6) Remove the CD mechanism assembly.
- (7) Reattach the heat sink with two screws to the main board. (Refer to Disassembly method.)
- (8) Connect the main board, front panel assembly, bottom chassis assembly and CD mechanism assembly with the extension cords.

### CAUTION :

**Be sure to attach a heat sink on the power amplifier IC of a main board when supplying the power.  
If voltage is applied without attaching the heat sink, the power amplifier IC will be destroyed by heat.**

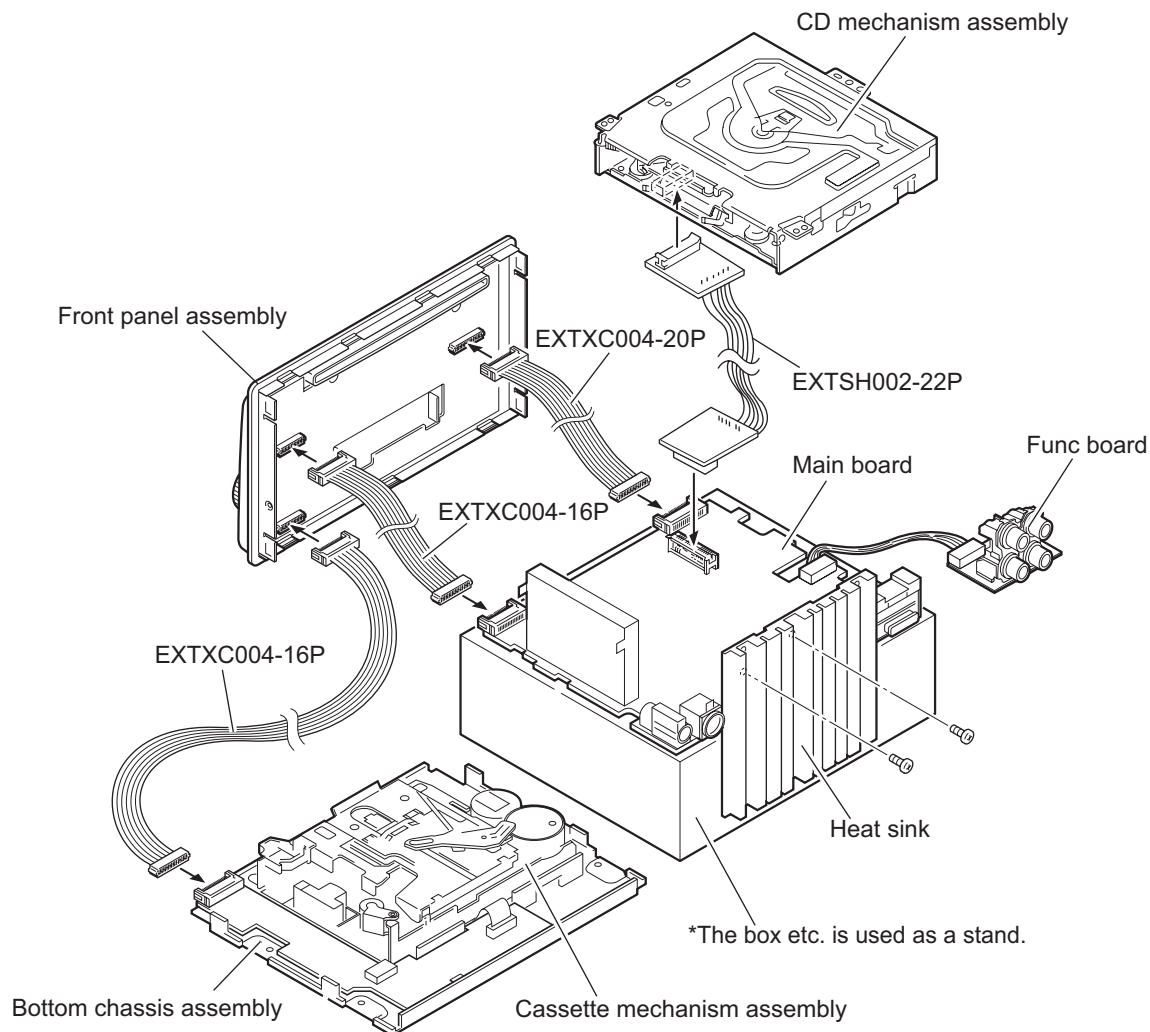

## 4.2 Service mode

Set up

Press POWER ON [SEL] → [POWER] → [CD EJECT] together more than 2 sec.

UP,DW button to select

SEL button to determination

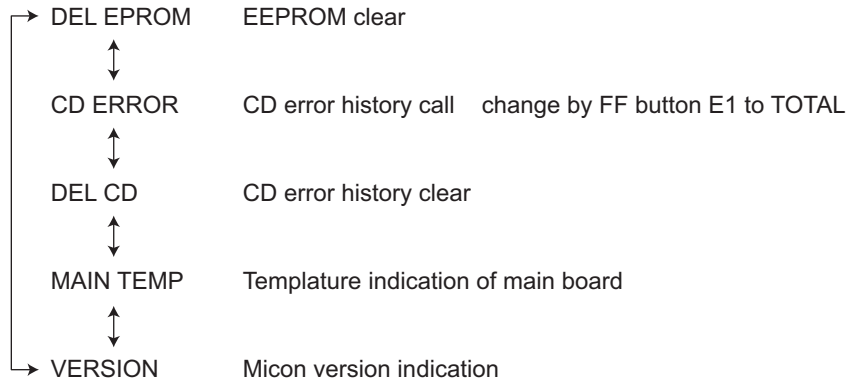

For next operation, service mode is stop automatically.

1. No input signal (key operation) more than 5 sec.
2. press other key without SEL,UP,DOWN.
3. ACC to OFF.

# SECTION 5 TROUBLESHOOTING

## 5.1 Feed section

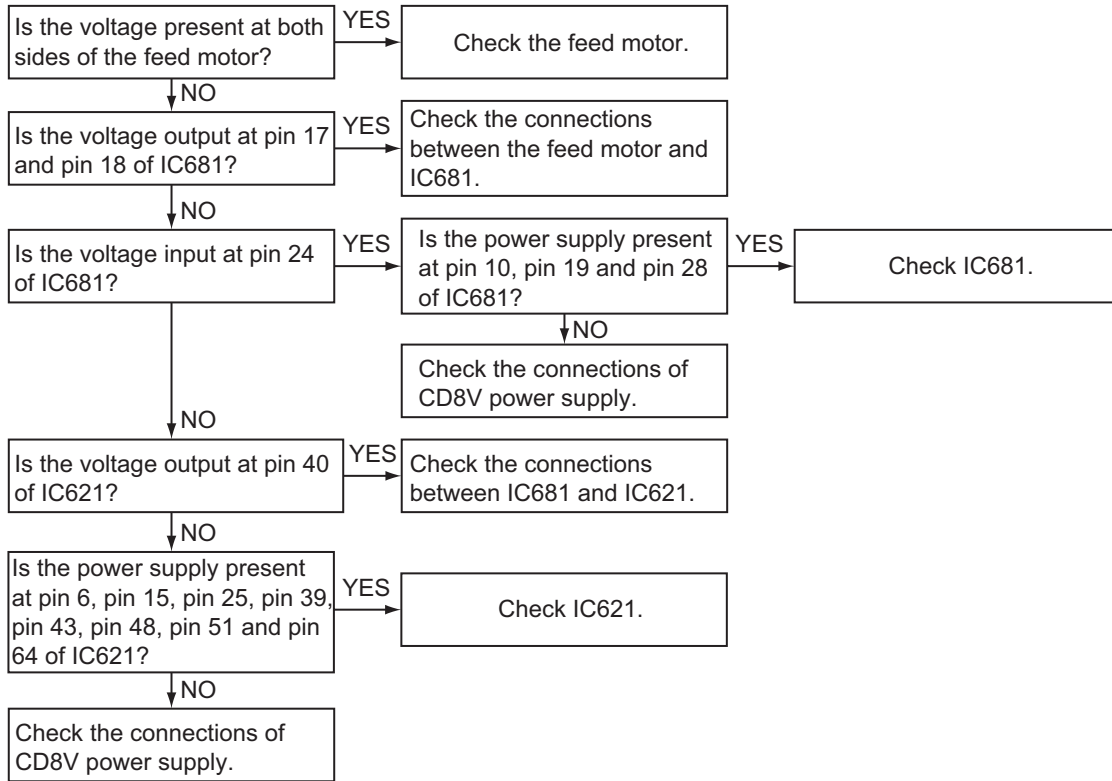

## 5.2 Focus section

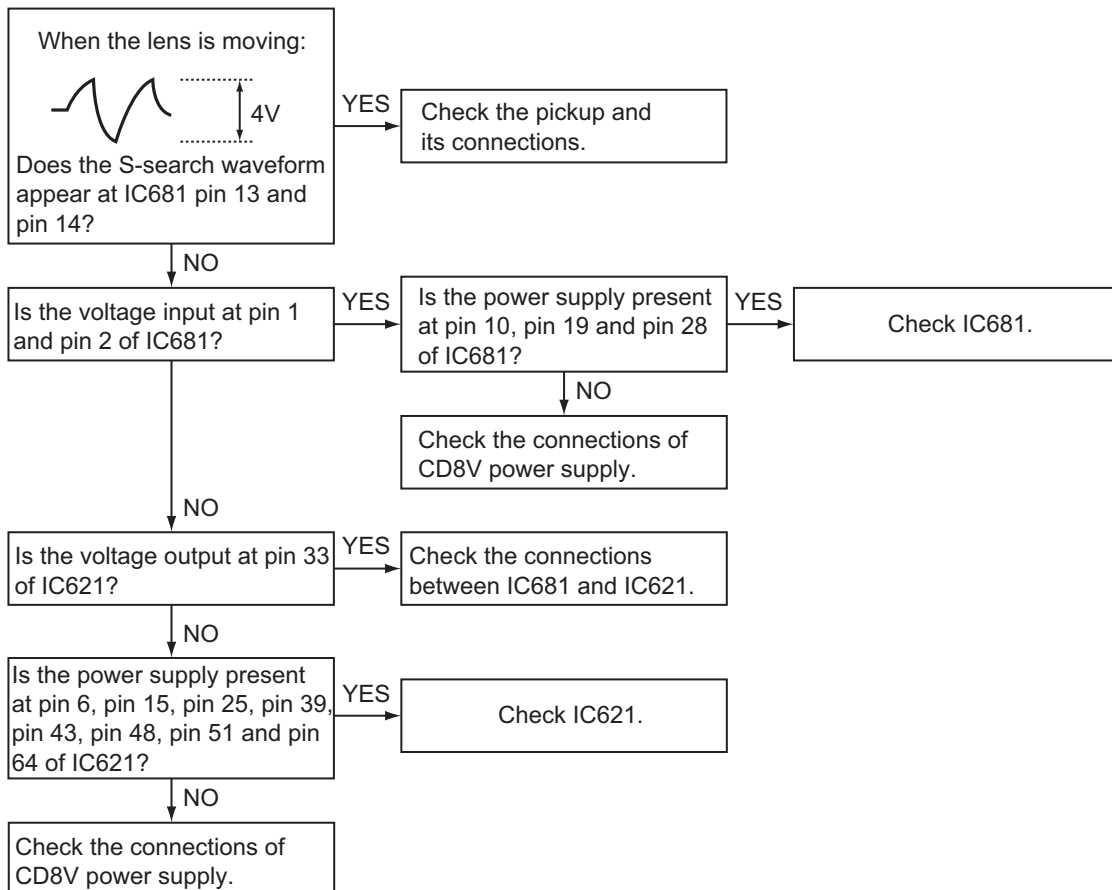



### 5.3 Spindle section

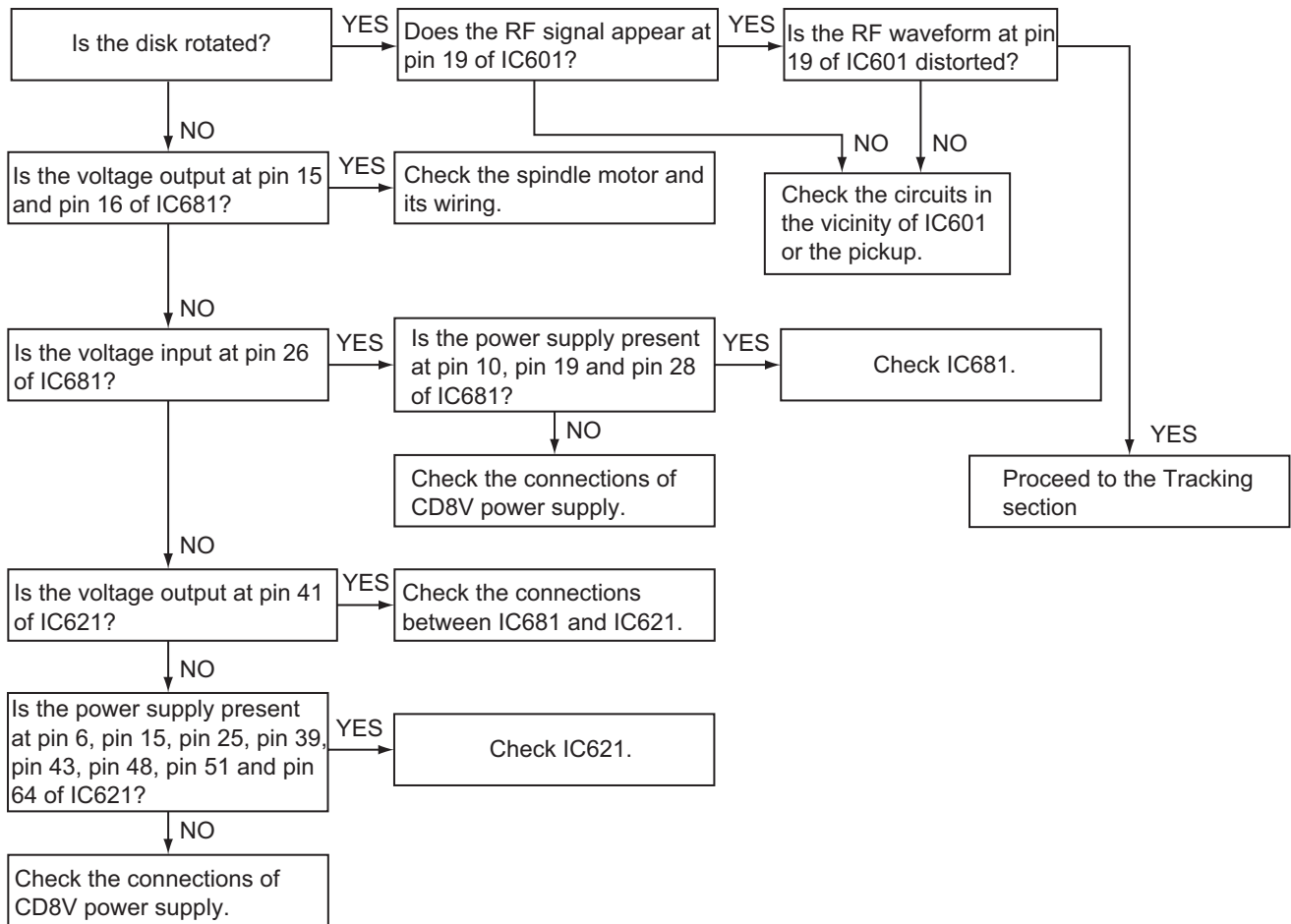

### 5.4 Tracking section

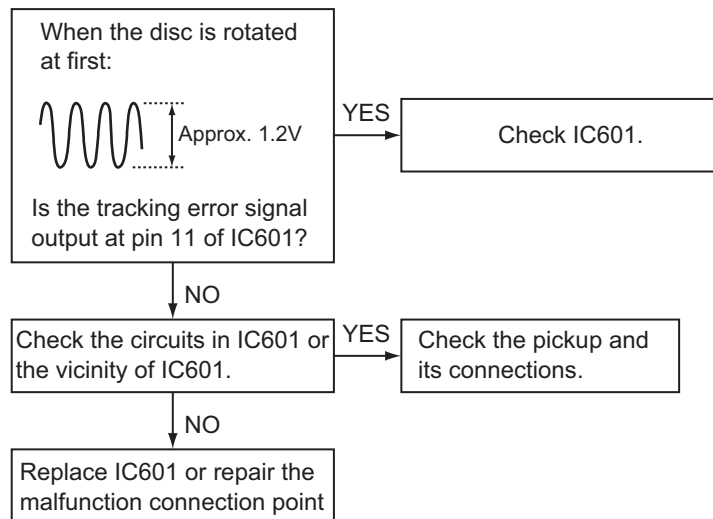

## 5.5 Signal processing section

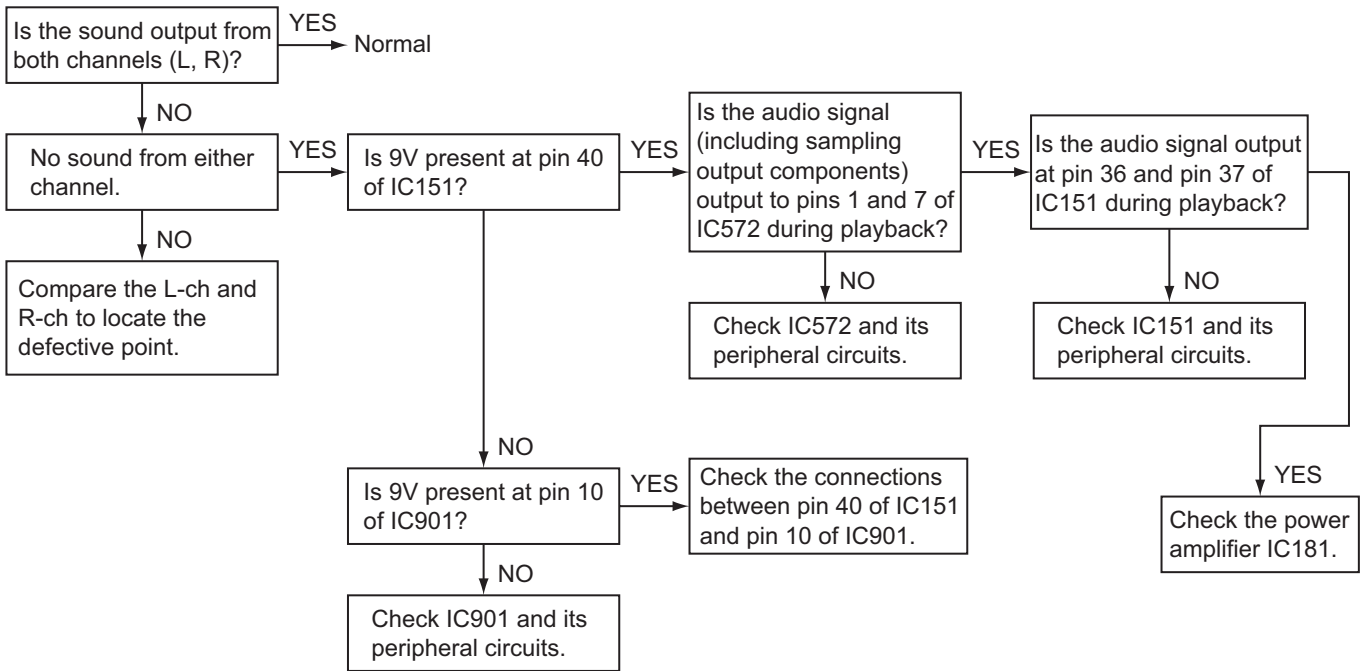

## 5.6 Maintenance of laser pickup

- (1) Cleaning the pick up lens  
Before you replace the pick up, please try to clean the lens with a alcohol soaked cotton swab.
- (2) Life of the laser diode  
When the life of the laser diode has expired, the following symptoms will appear.
  - The level of RF output (EFM output: amplitude of eye pattern) will be low.

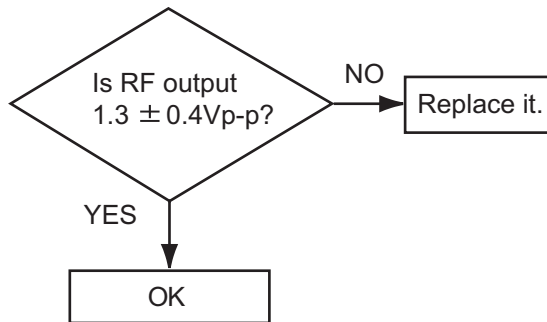

- (3) Semi-fixed resistor on the APC PC board  
The semi-fixed resistor on the APC printed circuit board which is attached to the pickup is used to adjust the laser power. Since this adjustment should be performed to match the characteristics of the whole optical block, do not touch the semi-fixed resistor.  
If the laser power is lower than the specified value, the laser diode is almost worn out, and the laser pickup should be replaced. If the semi-fixed resistor is adjusted while the pickup is functioning normally, the laser pickup may be damaged due to excessive current.

## 5.7 Replacement of laser pickup

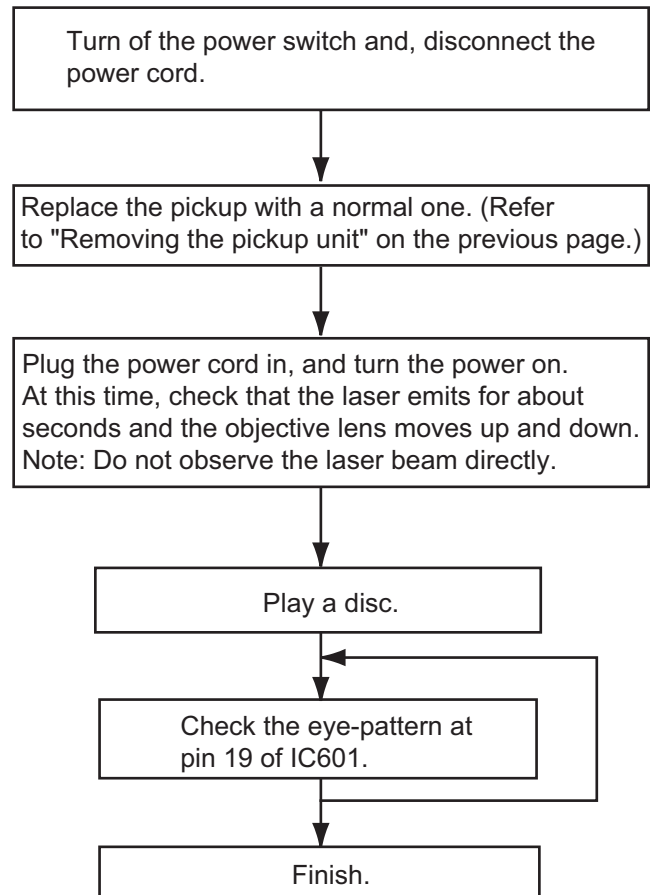

**5.8 16 PIN CORD DIAGRAM**

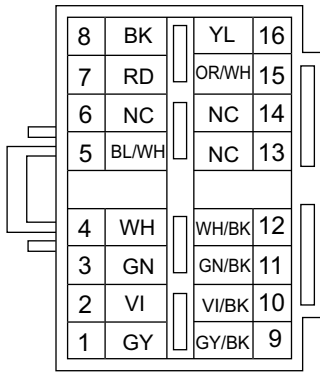

BK	Black	GN	Green
RD	Red	VI	Violet
BL	Blue	GY	Gray
WH	White	YL	Yellow
		OR	Orange

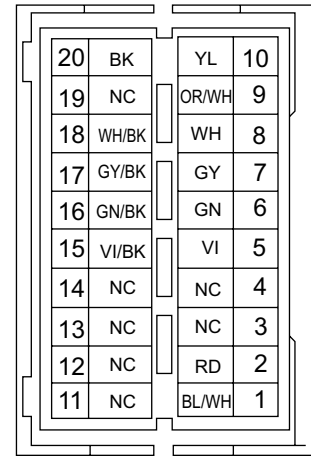





**JVC**

Victor Company of Japan, Limited  
Mobile Entertainment Business Group Mobile Entertainment Category 10-1,1chome,Ohwatari-machi,Maebashi-city,371-8543,Japan

(No.MA244)

# JVC



ENGLISH

INDONESIA

**CD/CASSETTE RECEIVER**

**KW-TC411/KW-TC410/  
KW-TC111/KW-TC110**

**ALAT PENERIMA CD/KASET**

**KW-TC411/KW-TC410/  
KW-TC111/KW-TC110**

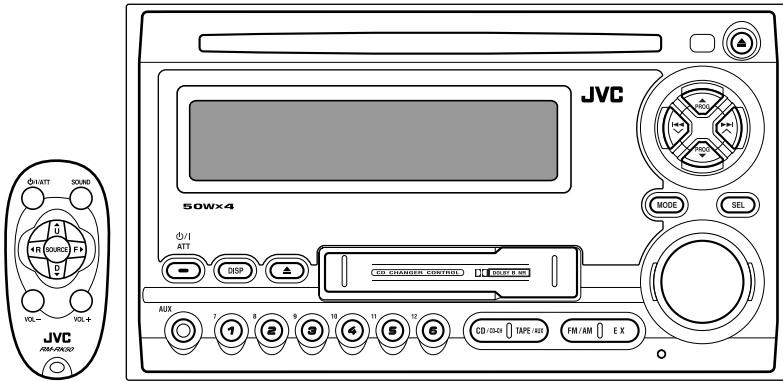

**KW-TC411/KW-TC410:**



**KW-TC111/KW-TC110:**



For canceling the display demonstration, see page 8.  
Untuk membatalkan tampilan demonstrasi, lihat halaman 8.

## **INSTRUCTIONS BUKU PETUNJUK**

GET0315-001A  
[UN]

Thank you for purchasing a JVC product.

Please read all instructions carefully before operation, to ensure your complete understanding and to obtain the best possible performance from the unit.

## IMPORTANT FOR LASER PRODUCTS

1. CLASS 1 LASER PRODUCT
2. **CAUTION:** Do not open the top cover. There are no user serviceable parts inside the unit; leave all servicing to qualified service personnel.
3. **CAUTION:** Visible and invisible laser radiation when open and interlock failed or defeated. Avoid direct exposure to beam.
4. REPRODUCTION OF LABEL: CAUTION LABEL, PLACED OUTSIDE THE UNIT.

<b>CAUTION:</b> Visible and invisible laser radiation when open and interlock failed or defeated. AVOID DIRECT EXPOSURE TO BEAM.	<b>ADVARSEL:</b> Synlig og usynlig laserstråling når maskinen er åpen eller interlocken fejler. Undgå direkte eksponering til stråling.	<b>WARNING:</b> Synlig och osynlig laserstråling när den öppnas och spärren urkopplas. Beträkta ej strålen.	<b>VARO:</b> Avtallassa ja suojalukitus ohjettuna tai viallisena olet alitilina näkyvälle ja näkymättömälle lasersträilylle. Vältä säteen kohdistamista suoraan itseesi. (1)
--	---	---	--

### Warning:

If you need to operate the unit while driving, be sure to look ahead carefully or you may be involved in a traffic accident.

### Caution on volume setting:

Discs produce very little noise compared with other sources. Lower the volume before playing a disc to avoid damaging the speakers by the sudden increase of the output level.

### How to reset your unit

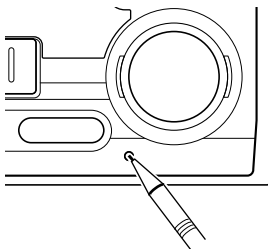

*This will reset the microcomputer. Your preset adjustments will also be erased.*

### How to forcibly eject a disc

If a disc cannot be recognized or cannot be ejected, eject the disc as follows.



- If this does not work, reset your unit.
- Be careful not to drop the disc when it ejects.



# Contents

How to reset your unit .....	2	<b>Tape operations .....</b>	<b>17</b>
How to forcibly eject a disc.....	2	<b>Playing a tape.....</b>	<b>17</b>
How to read this manual .....	4	Finding the beginning of a tune.....	17
How to use the MODE button .....	4	Other convenient tape functions .....	17
<b>Control panel — KW-TC411/ KW-TC410/KW-TC111/KW-TC110....</b>	<b>5</b>	<b>Sound adjustments .....</b>	<b>18</b>
Parts identification .....	5	<b>Selecting preset sound modes   (EQ: equalizer).....</b>	<b>18</b>
<b>Remote controller — RM-RK50 ...</b>	<b>6</b>	Adjusting the sound.....	18
Main elements and features .....	6	Storing your own sound adjustments.....	19
<b>Getting started.....</b>	<b>7</b>	<b>General settings — PSM .....</b>	<b>20</b>
<b>Basic operations.....</b>	<b>7</b>	Basic procedure .....	20
Canceling the display demonstrations ...	8	<b>External component operations... 22</b>	
Setting the clock .....	8	<b>Playing an external component .....</b>	<b>22</b>
<b>Radio operations .....</b>	<b>9</b>	<b>Maintenance .....</b>	<b>23</b>
<b>Listening to the radio.....</b>	<b>9</b>	Handling discs .....	23
Storing stations in memory.....	9	Handling cassettes .....	23
Listening to a preset station.....	10	<b>More about this unit.....</b>	<b>24</b>
Scanning broadcast stations.....	10	<b>Troubleshooting .....</b>	<b>27</b>
Assigning titles to the stations.....	11	<b>Specifications .....</b>	<b>29</b>
<b>Disc operations .....</b>	<b>12</b>		
<b>Playing a disc in the unit .....</b>	<b>12</b>		
<b>Connecting the CD changer .....</b>	<b>13</b>		
<b>Playing discs in the CD changer .....</b>	<b>13</b>		
Other main functions .....	15		
Changing the display information .....	15		
Selecting the playback modes.....	16		

## For safety....

- Do not raise the volume level too much, as this will block outside sounds, making driving dangerous.
- Stop the car before performing any complicated operations.





## Temperature inside the car....

If you have parked the car for a long time in hot or cold weather, wait until the temperature in the car becomes normal before operating the unit.

## How to read this manual

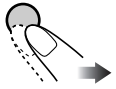
The following methods are used to make the explanations simple and easy-to-understand:

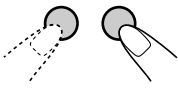
- Some related tips and notes are explained in “More about this unit” (see pages 24 – 26).
- Button operations are mainly explained with the illustrations as follows:

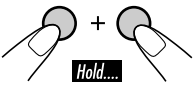
	Press briefly.
	Press repeatedly.
	Press either one.
	
	Press and hold until your desired response begins.
	Press and hold both buttons at the same time.

The following marks are used to indicate...

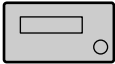

: Built-in CD player operations.



: External CD changer operations.

## How to use the MODE button

Press MODE repeatedly to select the different functions available during play.

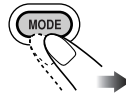

Time countdown indicator

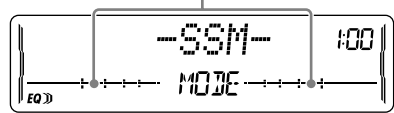

Ex.: When “SSM” is selected

### While listening to the radio:

- You cannot select “SSM” or “SCAN” if you are listening to the station stored in the EX (extra) button, see page 10 for details.

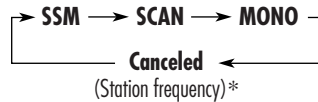

### While listening to a disc:

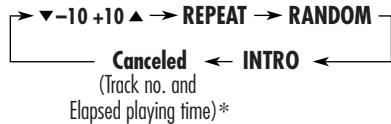

### While listening to a tape:

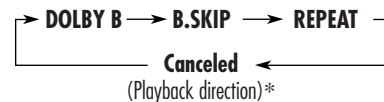

### While adjusting the sound mode:

- Pressing MODE allows you to store the adjusted sound mode into memory. (See page 19 for details.)

\* Depending on the level meter setting. (See page 20 for details.)

## Parts identification

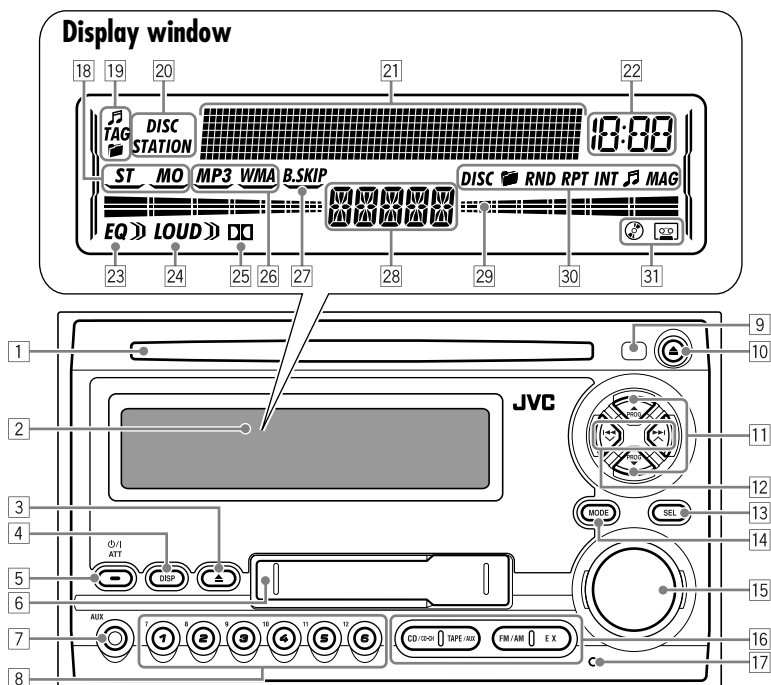

- 1 Loading slot
- 2 Display window
- 3 ▲ (tape eject) button
- 4 DISP (display) button
- 5 ⏻/⏪ ATT (standby/on attenuator) button
- 6 Cassette compartment
- 7 AUX (auxiliary) input jack
- 8 Number buttons
- 9 Remote sensor
  - *DO NOT* expose the remote sensor to strong light (direct sunlight or artificial lighting).
- 10 ▲ (CD eject) button
- 11 ▲ PROG (program) / ▼ PROG (program) buttons
- 12 ◀◀ ◻ / ▶▶ ▲ buttons
- 13 SEL (select) button
- 14 MODE button
- 15 Control dial
- 16 Source buttons—CD/CD-CH, TAPE/AUX, FM/AM, EX (extra)
- 17 Reset button

### Display window

- 18 Tuner reception indicators—ST (stereo), MO (monaural)
- 19 Disc information indicators— (track/file), TAG (ID3 Tag), (folder)
- 20 Text name indicators—DISC, STATION
- 21 Main display, level meter
- 22 Clock indicator
- 23 EQ (equalizer) indicator
- 24 LOUD (loudness) indicator
- 25 (Dolby B NR) indicator
- 26 Playback disc indicators—MP3, WMA
- 27 B.SKIP (blank skip) indicator
- 28 Source display
- 29 Level meter, volume meter, time countdown indicator
- 30 Playback mode indicators—DISC, (folder), RND (random), RPT (repeat), INT (intro), (track/file), MAG (magazine)
- 31 Loaded source indicators— (disc), (tape)

## Installing the lithium coin battery (CR2025)

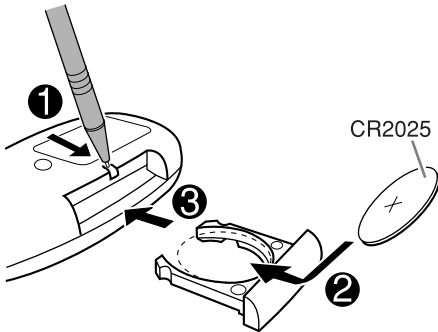

- When operating, aim the remote controller directly at the remote sensor on the unit. Make sure there is no obstacle in between.

### Warning:

- Do not install any battery other than CR2025 or its equivalent; otherwise, it may explode.
- Store the battery in a place where children cannot reach to avoid risk of accident.
- To prevent the battery from over-heating, cracking, or starting a fire:
  - Do not recharge, short, disassemble, heat the battery, or dispose of it in a fire.
  - Do not leave the battery with other metallic materials.
  - Do not poke the battery with tweezers or similar tools.
  - Wrap the battery with tape and insulate when throwing away or saving it.

### Caution:

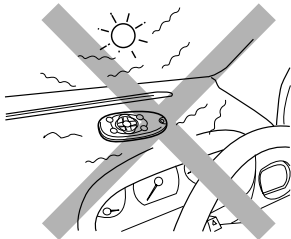

## Main elements and features

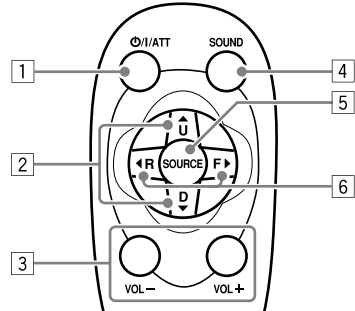

1. **⏻/I/ATT** (standby/on/attenuator) button
  - Turns the power on if pressed briefly or attenuates the sound when the power is on.
  - Turns the power off if pressed and held.
2. **▲ U (up) / D (down) ▼** buttons
  - Changes the FM/AM bands with ▲ U only.
  - Changes the preset stations with D ▼ only.
  - Changes the folder of the MP3/WMA discs (only for KW-TC411/KW-TC410).
  - Changes the tape directions with ▲ U only.
  - While playing an MP3 disc on an MP3-compatible CD changer:
    - Changes the disc if pressed briefly.
    - Changes the folder if pressed and held.
3. **VOL - / VOL +** buttons
  - Adjusts the volume level.
4. **SOUND** button
  - Selects the sound mode (EQ: equalizer).
5. **SOURCE** button
  - Selects the source.
6. **◀ R (reverse) / F (forward) ▶** buttons
  - Searches for stations if pressed briefly.
  - Fast-forwards or reverses the track if pressed and held.
  - Changes the tracks of the disc if pressed briefly.
  - Fast-forwards or reverses the tape if pressed and held.\*
  - Finds the beginning of a tune (MMS) while listening to a tape if pressed briefly.\*

\* To release these operations, press ▲ U. Playback resumes.

# Getting started

## Basic operations

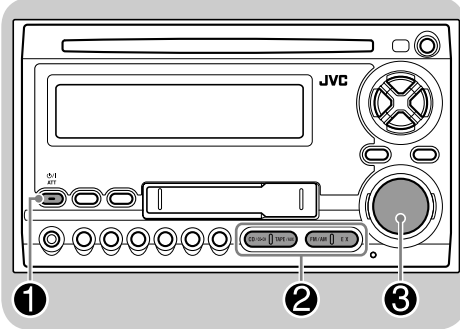

**1** Turn on the power.

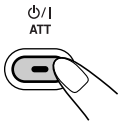

**2** For FM/AM tuner

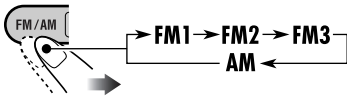

For your favorite station



• Stored your favorite station, see page 10 for details.

For CD/CD-CH



For TAPE/AUX



\* You cannot select these sources if they are not ready.

**3** Adjust the volume.

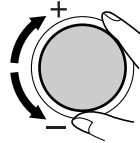

Volume level appears.



Volume level indicator

**4** Adjust the sound as you want.  
(See pages 18 and 19.)

### To drop the volume in a moment (ATT)

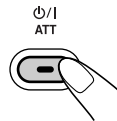

To restore the sound, press it again.

### To turn off the power

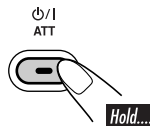

## Canceling the display demonstrations

If no operations are done for about 20 seconds, display demonstration starts.

[Initial: DEMO ON]—see page 20.

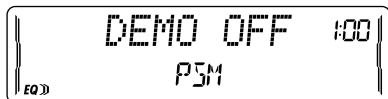
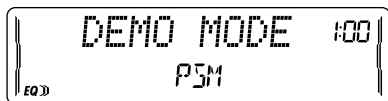
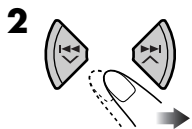

**4** Finish the procedure.



### To activate the display demonstration

In step **3** above...



DEMO OFF ↔ DEMO ON

## Setting the clock



**2** Set the hour and minute.

**1** Select “CLOCK HOUR,” then adjust the hour.

**2** Select “CLOCK MIN,” (minute) then adjust the minute.

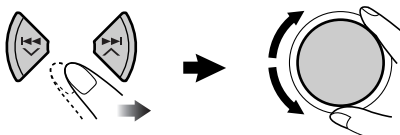

**3** Finish the procedure.



# Radio operations

## Listening to the radio

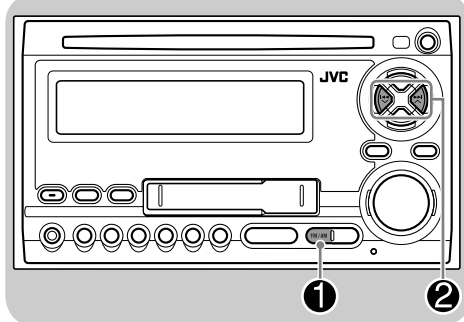

**1**

Lights up when receiving an FM stereo broadcast with sufficient signal strength.

Selected band appears.

**2** Start searching for a station.

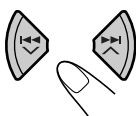

When a station is received, searching stops.

To stop searching, press the same button again.

### To tune in to a station manually

In step 2 above...

**1**

Hold...

**2** Select the desired station frequencies.

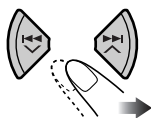

### When an FM stereo broadcast is hard to receive

**1**

**2**

Lights up when monaural mode is activated.



Reception improves, but stereo effect will be lost.

To restore the stereo effect, repeat the same procedure. Then, in step 2, select “MONO OFF.”

## Storing stations in memory

You can preset six stations for each band.

### FM station automatic presetting—SSM (Strong-station Sequential Memory)

**1** Select the FM band (FM1 – FM3) you want to store into.

To be continued....

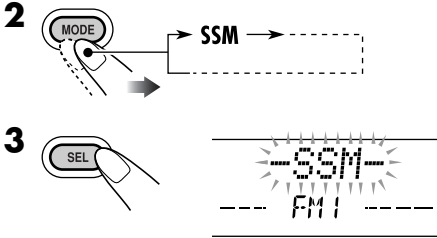

“SSM” flashes, then disappears when automatic presetting is over.

Local FM stations with the strongest signals are searched and stored automatically in the FM band.

### Manual presetting

Ex.: Storing FM station of 92.5 MHz into the preset number 4 of the FM1 band.

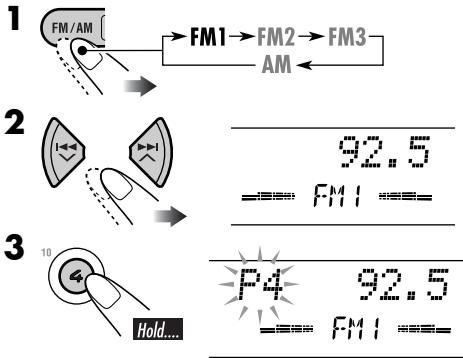

Preset number flashes for a while.

### Storing your favorite station into the EX (extra) button

Ex.: Storing your favorite FM station of 92.5 MHz into the EX button

While listening to an FM station, tune in to your favorite station, then...

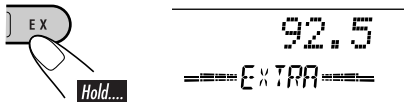

### Listening to a preset station

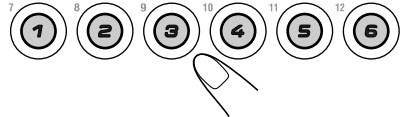
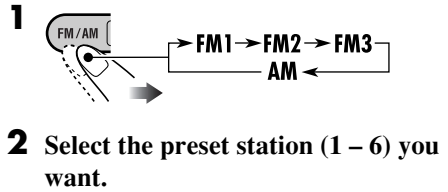

or

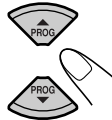

### To tune in to your favorite station (EX)



If you press the button again, the previous source will be played back again.

### Scanning broadcast stations

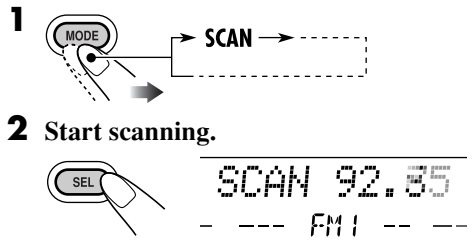

Each time a broadcast is tuned in, scanning stops for about 5 seconds (tuned frequency appears on the display), and you can check what program is now being broadcast.

3 Start listening to the program.





## Assigning titles to the stations

You can assign titles to 30 station frequencies (including both FM and AM). Each station name can be assigned up to 10 characters. However, you cannot assign title to the station frequency stored in the EX button.

**1** Tune in to the station you would like to assign a title to.

**2** Enter the assigning mode.



**3** Assign a title.

**1** Select a character set.

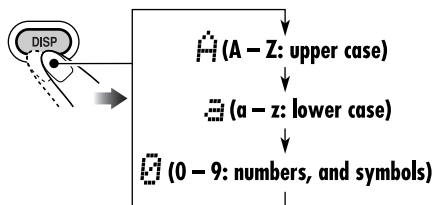

**2** Select a character.

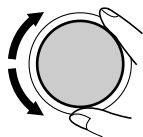

**3** Move to the next (or previous) character position.

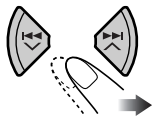

**4** Repeat steps **1** to **3** until you finish entering the title.

**4** Finish the procedure.



### To erase the entire title

In step **3** on the left...



### To change the information shown on the display

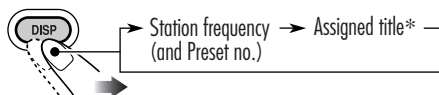

\* If no title is assigned, "NO NAME" appears for a while.

### Available characters

Upper case

A	B	C	D	E	F	G	H	I	J	K	L	M	N
O	P	Q	R	S	T	U	V	W	X	Y	Z	space	

Lower case

a	b	c	d	e	f	g	h	i	j	k	l	m	n
o	p	q	r	s	t	u	v	w	x	y	z	space	

Numbers and symbols

0	1	2	3	4	5	6	7	8	9	!	"	#	\$
%	&	'	(	)	*	+	,	-	.	/	:	;	<
=	>	?	@	_	`	space							

# Disc operations

## Playing a disc in the unit

- KW-TC111/KW-TC110 cannot play back MP3 or WMA discs in the unit.
- KW-TC111/KW-TC110 can only control MP3 discs in an MP3-compatible CD changer.

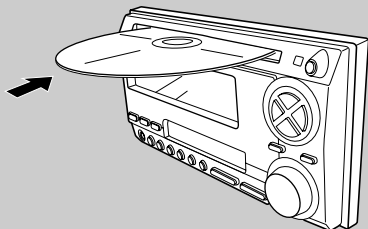

All tracks will be played repeatedly until you change the source or eject the disc.

- When inserting an MP3 or a WMA disc:

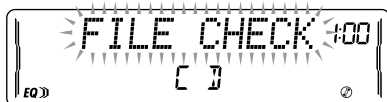

Total folder number      Total file number

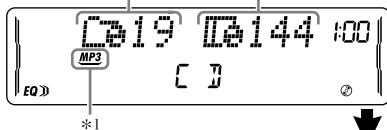

**Disc information appears automatically (see page 15).**

Current track number\*2      Elapsed playing time\*2

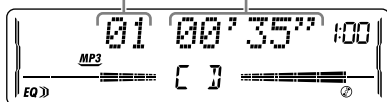

- When inserting an audio CD or a CD Text disc:

Total track number of the inserted disc      Total playing time of the inserted disc

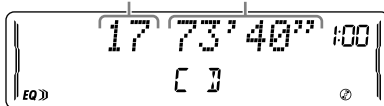

**CD Text: Disc title/performer → Track title appears automatically (see page 15).**

Current track number\*2      Elapsed playing time\*2

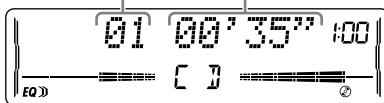

## To stop play and eject the disc



The source changes to the last selected source.

\*1 Either the MP3 or WMA indicator lights up depending on the detected file.

\*2 Depending on the level meter setting. (See page 20 for details.)

## Connecting the CD changer

Connection cord supplied for the CD changer

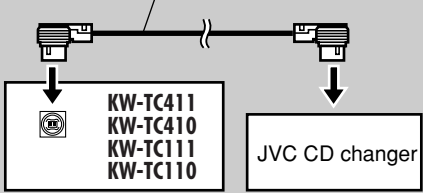

## Playing discs in the CD changer

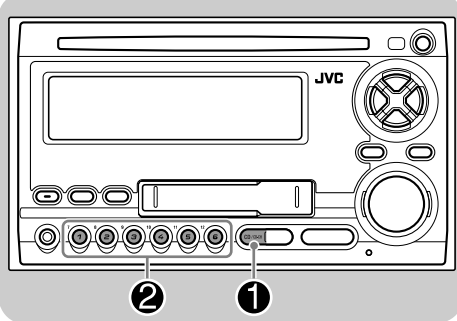

### Before connecting the CD changer

- To prevent short circuits, it is recommended to disconnect the car battery's negative terminal and make all electrical connections before connecting the CD changer.
- When mounting this unit into your car, be sure to use the screws provided.
- When tightening screws or bolts, be careful not to pinch any connection cord.
- If you are not sure how to connect the CD changer correctly, consult your car dealer or JVC car audio dealer, or have it installed by a qualified technician.

### About the CD changer

- It is recommended to use a JVC MP3-compatible CD changer with your unit.
- You can also connect other CH-X series CD changers (except CH-X99 and CH-X100). However, they are not compatible with MP3 discs, so you cannot play back MP3 discs.
  - You cannot play any WMA disc in the CD changer.
  - You cannot use the KD-MK series CD changers with this unit.
  - Disc text information recorded in the CD Text can be displayed when a JVC CD Text compatible CD changer is connected.

All tracks of the inserted discs in the magazine will be played repeatedly until you change the source or eject the magazine from the CD changer.

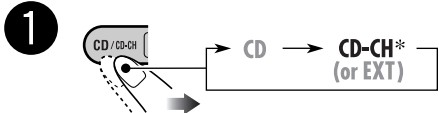

\* If you have changed "EXT INPUT" setting to "EXT INPUT" (see page 21), you cannot select the CD changer.

### 2 Select a disc.

For disc number from 01 – 06:

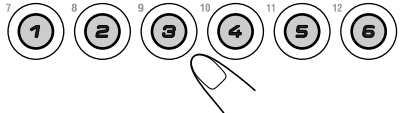

For disc number from 07 – 12:

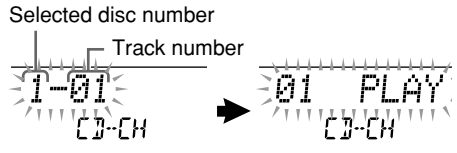
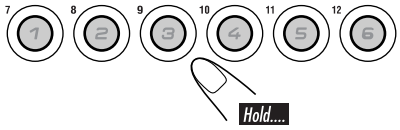

- When the current disc is an MP3 disc:

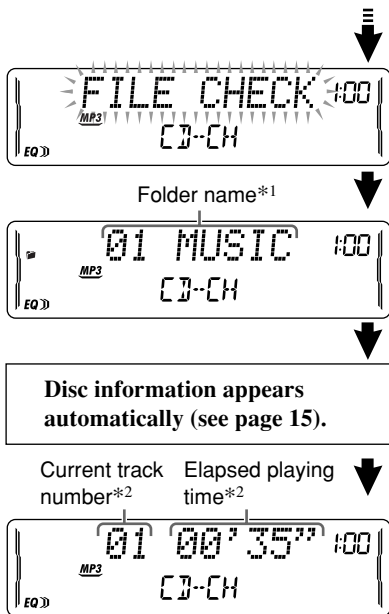

- When the current disc is an audio CD or a CD Text disc:

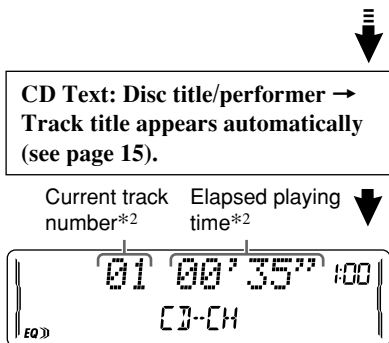

\*1 "ROOT" appears if no folder is included in the disc.  
 \*2 Depending on the level meter setting. (See page 20 for details.)

### To fast-forward or reverse the track

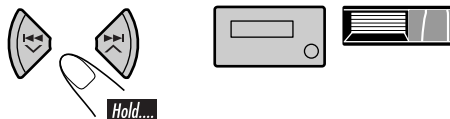

### To go to the next or previous tracks

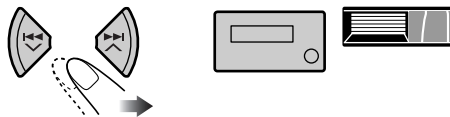

### To go to the next or previous folders—for MP3 and WMA discs

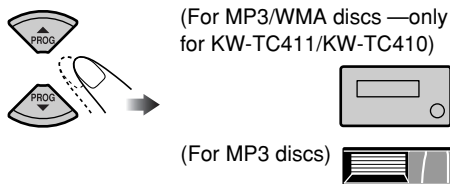

### To locate a particular track—for CD or folder—for MP3 or WMA discs (only for KW-TC411/KW-TC410) directly

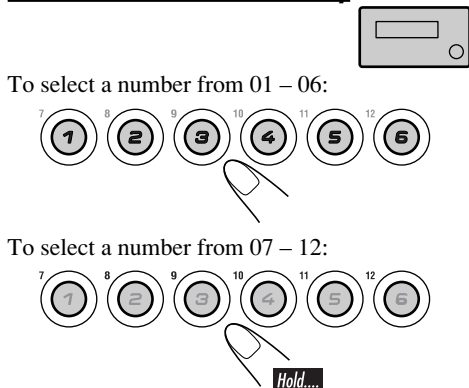

- To use folder search on MP3/WMA discs, it is required that folders are assigned with 2-digit numbers at the beginning of their folder names—01, 02, 03, and so on.

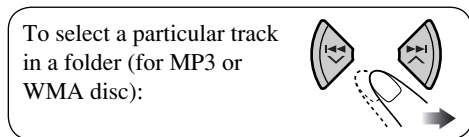

## Other main functions

### ■ Skipping a track quickly during play

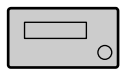

**Only possible on JVC MP3-compatible CD changer**

- For MP3 or WMA disc, you can skip a track within the same folder.

Ex.: To select track 32 while playing track 6

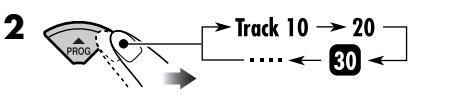
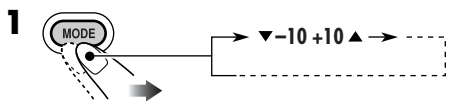

First time you press ▲ PROG/▼ PROG button, the track skips to the nearest higher or lower track with a track number of multiple ten (ex. 10th, 20th, 30th). Then each time you press the button, you can skip 10 tracks.

- After the last track, the first track will be selected and vice versa.



### ■ Prohibiting disc ejection

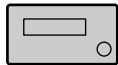

You can lock a disc in the loading slot.

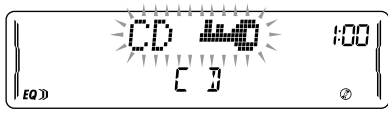
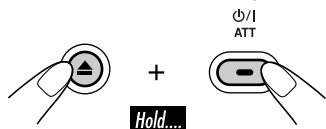

To cancel the prohibition, repeat the same procedure.

## Changing the display information

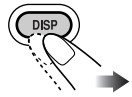

### ■ While playing an audio CD or a CD Text



### ■ While playing an MP3 or WMA disc

- When "TAG DISP" is set to "TAG ON" (see page 21)

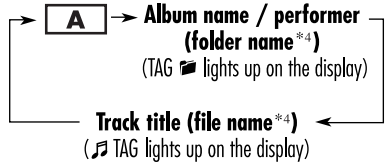

- When "TAG DISP" is set to "TAG OFF"

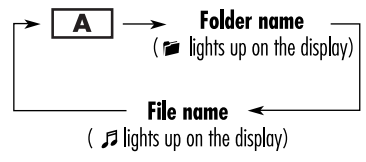

**A** : Current track/file number and Elapsed playing time

\*3 If the current disc is an audio CD, "NO NAME" appears.  
 \*4 If an MP3/WMA file does not have ID3 tags, folder name and file name appear. In this case, the TAG indicator will not light up.

## Selecting the playback modes

You can use only one of the following playback modes at a time.

Select your desired playback mode.

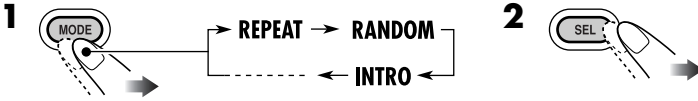

### Repeat play

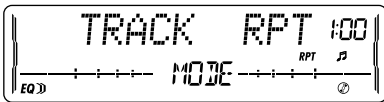

Ex.: When "TRACK RPT" is selected

### Mode

### Plays repeatedly

- TRACK RPT** : The current track.
  - RPT and 🎵 light up.
- FOLDER RPT\*1** : All tracks of the current folder.
  - 📁 and RPT light up.
- DISC RPT\*2** : All tracks of the current disc.
  - DISC and RPT light up.
- REPEAT OFF** : Cancels.

### Random play

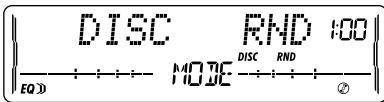

Ex.: When "DISC RND" is selected

### Mode

### Plays at random

- FOLDER RND\*1** : All tracks of the current folder, then tracks of the next folder and so on.
  - 📁 and RND light up.
- DISC RND** : All tracks of the current disc.
  - DISC and RND light up.
- MAG RND\*2** : All tracks of the inserted discs.
  - RND and MAG light up.
- RANDOM OFF** : Cancels.

### Intro scan

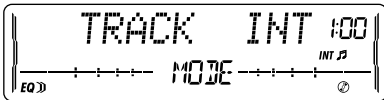

Ex.: When "TRACK INT" is selected

### Mode

### Plays the beginning 15 seconds of...

- TRACK INT** : All tracks of the current disc.
  - INT and 🎵 light up.
- FOLDER INT\*1** : The first track of every folder of the current disc.
  - 📁 and INT light up.
- DISC INT\*2** : The first tracks of the inserted discs.
  - DISC and INT light up.
- INTRO OFF** : Cancels.

\*1 Only while playing an MP3 disc or WMA disc.

\*2 Only while playing discs in the CD changer.

# Tape operations

## Playing a tape

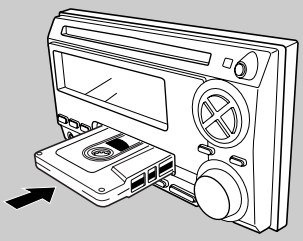

Playback starts automatically. When one side of the tape reaches its end during play, the other side of the tape automatically starts playing. (Auto Reverse)

## Finding the beginning of a tune

Multi Music Scan (MMS) allows you to automatically start playback from the beginning of a specified tune.

Specify the tune you want to locate (how many tunes ahead of or before the current tune)

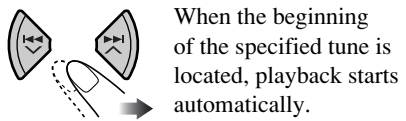

When the beginning of the specified tune is located, playback starts automatically.

**MMS -9** ↔ **MMS -1**\*3, **MMS +1** ↔ **MMS +9**

\*3 Goes back to the beginning of the current tune.

## To change the playback direction

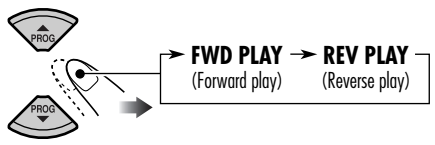

## To stop play and eject the cassette

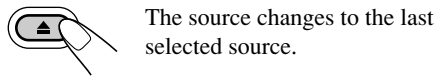

## To fast-forward or rewind a tape

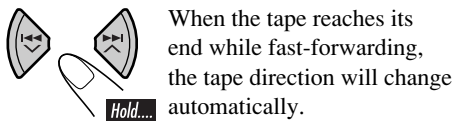

To stop fast-forwarding or rewinding, press ▲ PROG/▼ PROG.

## Prohibiting tape ejection

You can lock a tape in the loading slot.

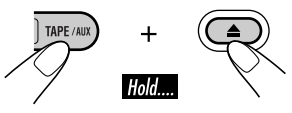

To cancel the prohibition, repeat the same procedure.

## Other convenient tape functions

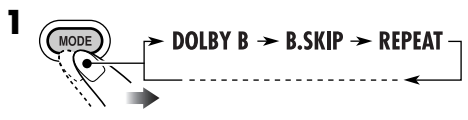

• To turn on or off Dolby B NR\*4

**DOLBY ON** ↔ **DOLBY OFF**  
( lights up on the display)

• To skip blank portions on the tape

**B.SKIP ON** ↔ **B.SKIP OFF**  
(**B.SKIP** lights up on the display)

• To play the current tune repeatedly

**REPEAT ON** ↔ **REPEAT OFF**  
(**RPT** lights up on the display)

\*4 Manufactured under license from Dolby Laboratories. "Dolby" and the double-D symbol are trademarks of Dolby Laboratories.

# Sound adjustments

## Selecting preset sound modes (EQ: equalizer)

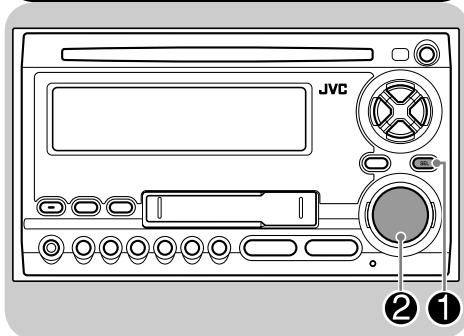

You can select a preset sound mode suitable to the music genre.

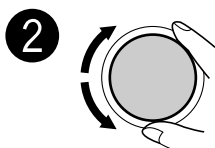
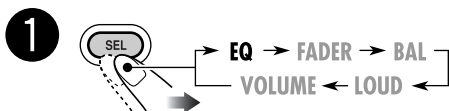

FLAT ≡ Hard Rock ≡ R & B ≡  
POP ≡ JAZZ ≡ DanceMusic ≡  
Country ≡ Reggae ≡ Classic ≡  
USER 1 ≡ USER 2 ≡ USER 3 ≡  
(back to the beginning)

### To select the sound mode directly

You can select the sound mode directly using the remote controller.

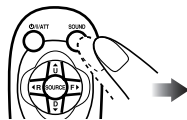

## Adjusting the sound

You can adjust the sound characteristics to your preference.

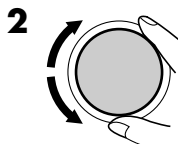
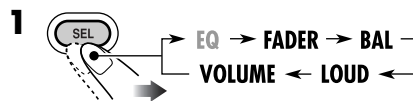

Indication	Range
<b>FADER</b> *1 Adjust the front and rear speaker balance.	R06 (Rear only) to F06 (Front only)
<b>BAL</b> (balance) Adjust the left and right speaker balance.	L06 (Left only) to R06 (Right only)
<b>LOUD</b> (loudness) Boost low and high frequencies to produce a well-balanced sound at low volume level.	LOUD ON ↑ LOUD OFF
<b>VOLUME</b> *2 Adjust the volume.	00 (min.) to 30 or 50 (max.)*3

\*1 If you are using a two-speaker system, set the fader level to "00."

\*2 Normally the control dial works as the volume control. So you do not have to select "VOLUME" to adjust the volume level.

\*3 Depending on the amplifier gain control setting. (See page 21 for details.)



## Storing your own sound adjustments

You can adjust the sound modes and store your own adjustments in memory.



**2** Select one of the sound mode to adjust.

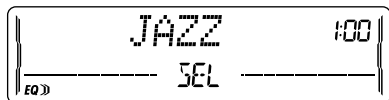
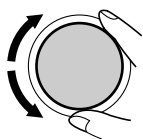

Ex.: When "JAZZ" is selected

**3** Select the sound elements to adjust while the selected sound mode is shown.

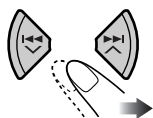

LOW LEVEL ⇄ LOW FREQ. ⇄  
LOW WIDTH ⇄ MID LEVEL ⇄  
MID WIDTH ⇄ HIGH LEVEL ⇄  
HIGH FREQ. ⇄ (back to the beginning)

- **(LOW, MID, HIGH) LEVEL:**  
Adjust the enhancement level.
- **(LOW, HIGH) FREQ:**  
Select the center frequency to adjust.
- **(LOW, MID) WIDTH :**  
Select the band width level.

**4** Adjust the selected sound elements while the indication on step 3 is shown.

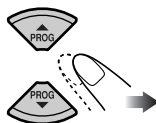

Indication	Preset values		
	LOW	MID	HIGH
LEVEL	-06 (min.) to +06 (max.)	-06 (min.) to +06 (max.)	-06 (min.) to +06 (max.)
FREQ	60Hz 80Hz 100Hz 120Hz	—	8kHz 10kHz 12kHz 15kHz
WIDTH	1 (min.) to 4 (max.)	1 (min.) to 2 (max.)	—

**5** Repeat steps 3 and 4 to set (or adjust) the other sound elements.

**6** Select one of the user sound modes (USER 1, USER 2, USER 3).

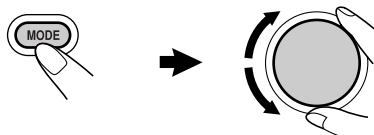

**7** Store the adjustments.



"MEMORY" appears for a while.

# General settings — PSM

## Basic procedure

You can change PSM (Preferred Setting Mode) items listed in the table that follows.

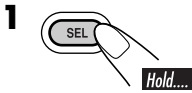

**2** Select a PSM item.

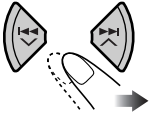

**3** Adjust the PSM item selected.

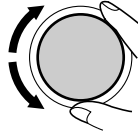

**4** Repeat steps 2 and 3 to adjust the other PSM items if necessary.

**5** Finish the procedure.



Indications	Selectable settings, [reference page]
<b>DEMO MODE</b> Display demonstration	<b>DEMO ON</b> : [Initial]; Display demonstration will be activated automatically if no operation is done for about 20 seconds, [8]. <b>DEMO OFF</b> : Cancels.
<b>CLOCK HOUR</b> Hour adjustment	1 – 12, [8] [Initial: 1 (1:00)]
<b>CLOCK MIN</b> Minute adjustment	00 – 59, [8] [Initial: 00 (1:00)]
<b>CLOCK DISP</b> Clock display	<b>CLOCK ON</b> : Clock time is shown on the display at all times even when the unit is turned off. <b>CLOCK OFF</b> : [Initial]; Clock time is shown when the unit is turned on. If the unit is turned off, pressing DISP will show the clock time for about 5 seconds.

### LEVELMETER Audio level meter

You can select one of the four different level meter patterns or a demonstration of all the patterns.

**LEVEL ALL** [Initial]  $\rightleftarrows$  **LEVEL 1**  $\rightleftarrows$  **LEVEL 2**  $\rightleftarrows$  **LEVEL 3**  $\rightleftarrows$  **LEVEL 4**  $\rightleftarrows$  **LEVEL OFF** (canceled)  $\rightleftarrows$  (back to the beginning)

**LEVEL ALL** : Demonstrates all the level meter patterns, each for about 20 seconds.

LEVEL 1

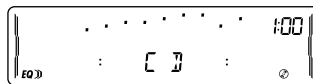

LEVEL 2

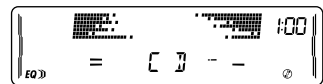

LEVEL 3

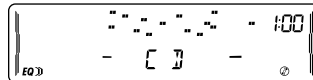

LEVEL 4

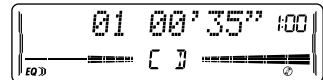

Indications	Selectable settings, [reference page]
<b>DIMMER</b> Dimmer	<b>AUTO</b> : [Initial]; Dims the display when you turn on the headlights.
	<b>ON</b> : Activates dimmer.
	<b>OFF</b> : Cancels.
<b>CONTRAST</b> Display contrast	<b>1 – 10</b> : Adjust the display contrast to make the display indications clear and legible. [Initial: 5]
<b>SCROLL</b> *1 Scroll	<b>ONCE</b> : [Initial]; Scrolls the disc information once.
	<b>AUTO</b> : Repeats scrolling (5-second intervals in between).
	<b>OFF</b> : Cancels. • Pressing DISP for more than one second can scroll the display regardless of the setting.
<b>EXT INPUT</b> *2 External input	<b>CHANGER</b> : [Initial]; To use a JVC CD changer, [13].
	<b>EXT INPUT</b> : To use another external component, [22].
<b>AUX ADJUST</b> Auxiliary input level adjustment	<b>AUX ADJ 00 – AUX ADJ 05</b> : Adjust the auxiliary input level accordingly, to avoid the sudden increase of the output level when changing the source from external component connected to the AUX input jack on the control panel. [Initial: AUX ADJ 00]
<b>TAG DISP</b> Tag display	<b>TAG ON</b> : [Initial]; Shows the ID3 tag while playing MP3/WMA tracks, [15].
	<b>TAG OFF</b> : Cancels.
<b>AMP GAIN</b> Amplifier gain control	You can change the maximum volume level of this unit.
	<b>LOW PWR</b> : VOLUME 00 – VOLUME 30 (Select this if the maximum power of the speaker is less than 50 W to avoid damaging the speaker.)
	<b>HIGH PWR</b> : [Initial]; VOLUME 00 – VOLUME 50
<b>IF FILTER</b> IF filter	<b>AUTO</b> : [Initial]; Increases the tuner selectivity to reduce noise interference between the stations. (Stereo effect will also be lost.)
	<b>WIDE</b> : Subject to noise interference from adjacent stations, but sound quality will not be degraded and will retain the stereo effect.

\*1 Some characters or symbols will not be shown (and will be blanked) or substituted on the display.

\*2 Cannot be selected if the source is "CD-CH" or "EXT."

# External component operations

## Playing an external component

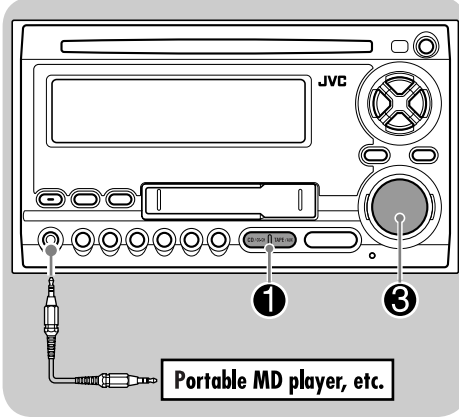

You can connect an external component to....

- CD changer jack on the rear using the Line Input Adapter—KS-U57 (not supplied) or AUX Input Adapter—KS-U58 (not supplied).
- AUX (auxiliary) input jack on the control panel.

### To connect an external component to the CD changer jack using KS-U57 or KS-U58

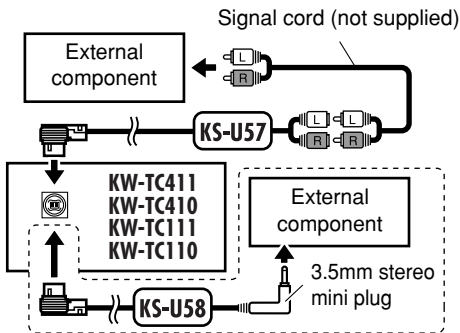

- 1** For selecting the external component connected to....
- AUX input jack

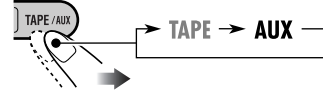

- CD changer jack on the rear using KS-U57 or KS-U58
- If “EXT” does not appear, see page 21 and select the external input (EXT INPUT).

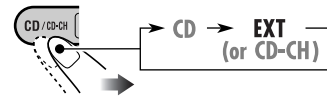

- 2** Turn on the connected component and start playing the source.

- 3** Adjust the volume.

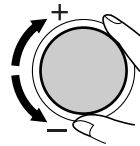

- 4** Adjust the sound as you want. (See pages 18 and 19.)

## Handling discs

### Moisture condensation

Moisture may condense on the lens inside the CD player in the following cases:

- After starting the heater in the car.
- If it becomes very humid inside the car.

Should this occur, the CD player may malfunction. In this case, eject the disc and leave the unit turned on for a few hours until the moisture evaporates.

### How to handle discs

When removing a disc from its case, press down the center holder of the case and lift the disc out, holding it by the edges.

Center holder



- Always hold the disc by the edges. Do not touch its recording surface.

When storing a disc into its case, gently insert the disc around the center holder (with the printed surface facing up).

- Make sure to store discs into the cases after use.

### To keep discs clean

A dirty disc may not play correctly. If a disc does become dirty, wipe it with a soft cloth in a straight line from center to edge.



- Do not use any solvent (for example, conventional record cleaner, spray, thinner, benzene, etc.) to clean discs.

### To play new discs

New discs may have some rough spots around the inner and outer edges. If such a disc is used, this unit may reject the disc.



To remove these rough spots, rub the edges with a pencil or ball-point pen, etc.

### Do not use the following discs:

Warped disc



Sticker



Sticker residue

Disc



Stick-on label

## Handling cassettes

### To clean the head

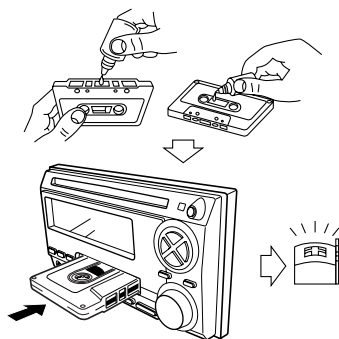

- Clean the heads after every 10 hours of use using a wet-type head cleaning tape (available at an audio store).

When the head becomes dirty, you may realize the following symptoms:

- Sound quality is reduced.
- Sound level decreases.
- Sound drops out.
- Do not touch the highly-polished head with any metallic or magnetic tools.

### To keep the tape clean

- Always store the cassettes in their storage cases after use.
- Do not store cassettes in the following places:
  - Subject to direct sunlight
  - With high humidity
  - At extremely hot temperatures

# More about this unit

## Basic operations

### Turning on the power

- By pressing the source buttons on the unit, you can also turn on the power. If the source is ready, playback also starts.

### Turning off the power

- If you turn off the ignition key without turning off this unit, the unit will automatically turn on when you turn on the ignition key next time. If the last selected source is ready for playback (ex. a disc or a tape is in the unit), playback starts automatically.
- If you turn off the power while listening to a disc, disc play will start from where playback has been stopped previously, next time you turn on the power.

### Selecting the sources

- When no disc or cassette is loaded in the unit, “CD” or “TAPE” cannot be selected.
- Without connecting to the CD changer, “CD-CH” cannot be selected.

## Tuner operations

### Storing stations in memory

- During SSM search...
  - All previously stored stations are erased and stations are stored newly.
  - Received stations are preset in No. 1 (lowest frequency) to No. 6 (highest frequency).
  - When SSM is over, the station stored in No. 1 will be automatically tuned in.
- When storing a station manually, a previously preset station is erased when a new station is stored in the same preset number.

## Disc operations

- KW-TC111/KW-TC110 cannot play back MP3 or WMA discs in the unit.
- KW-TC111/KW-TC110 can only control MP3 discs in an MP3-compatible CD changer.

### Caution for DualDisc playback

- The Non-DVD side of a “DualDisc” does not comply with the “Compact Disc Digital Audio” standard. Therefore, the use of Non-DVD side of a DualDisc on this product may not be recommended.

### General

- MP3 and WMA (Windows Media® Audio) “tracks” (words “file” and “track” are used interchangeably) are recorded in “folders.”
- This unit has been designed to reproduce CDs/CD Texts, and CD-Rs (Recordable)/CD-RWs (Rewritable) in audio CD (CD-DA), MP3 and WMA format.
- When a disc has been loaded, selecting “CD” for the playback source starts disc play.

### Inserting a disc

- When a disc is inserted upside down, the disc automatically ejects and the unit starts playing the last selected source.
- Do not insert 8 cm discs (single CD) and unusual shape discs (heart, flower, etc.) into the loading slot.

### Playing a disc

- While fast-forwarding or reversing on an MP3 or WMA disc, you can only hear intermittent sounds.

## Playing a CD-R or CD-RW

- Use only “finalized” CD-Rs or CD-RWs.
- This unit can play back only the files of the same type which is first detected if a disc includes both audio CD (CD-DA) files and MP3/WMA files.
- This unit can play back multi-session discs; however, unclosed sessions will be skipped while playing.
- Some CD-Rs or CD-RWs may not play back on this unit because of their disc characteristics, and for the following causes:
  - Discs are dirty or scratched.
  - Moisture condensation occurs on the lens inside the unit.
  - The pickup lens inside the unit is dirty.
  - CD-R/CD-RW on which the files are written with “Packet Write” method.
  - There are improper recording conditions (missing data, etc.) or media conditions (stain, scratch, warp, etc.).
- CD-RWs may require a longer readout time since the reflectance of CD-RWs is lower than that of regular CDs.
- Do not use the following CD-Rs or CD-RWs:
  - Discs with stickers, labels, or protective seal stuck to the surface.
  - Discs on which labels can be directly printed by an ink jet printer.
 Using these discs under high temperatures or high humidity may cause malfunctions or damages to the unit.

## Playing an MP3/WMA disc

- This unit can play back MP3/WMA files with the extension code <.mp3> or <.wma> (regardless of the letter case—upper/lower).
- This unit can show the names of albums, artists (performer), and ID3 Tag (Version 1.0, 1.1, 2.2, 2.3, or 2.4) for MP3 files and for WMA files.
- This unit can display only one-byte characters. No other characters can be correctly displayed (see page 11).

- This unit can play back MP3/WMA files meeting the conditions below:
  - Bit rate: 8 kbps — 320 kbps
  - Sampling frequency:
    - 48 kHz, 44.1 kHz, 32 kHz (for MPEG-1)
    - 24 kHz, 22.05 kHz, 16 kHz (for MPEG-2)
    - 48 kHz, 44.1 kHz, 32 kHz (for WMA)
  - Disc format: ISO 9660 Level 1/Level 2, Romeo, Joliet, Windows long file name
- The maximum number of characters for file/folder names vary among the disc format used (includes 4 extension characters—<.mp3> or <.wma>).
  - ISO 9660 Level 1: up to 12 characters
  - ISO 9660 Level 2: up to 31 characters
  - Romeo\*: up to 128 (72) characters
  - Joliet\*: up to 64 (36) characters
  - Windows long file name\*: up to 128 (72) characters

*\* The parenthetic figure is the maximum number of characters for file/folder names in case the total number of files and folders is 313 or more.*
- This unit can recognize the total of 512 files, of 200 folders, and of 8 hierarchies.
- This unit can play back the files recorded in VBR (variable bit rate).  
The files recorded in VBR have a discrepancy in elapsed time display, and do not show the actual elapsed time. This difference becomes noticeable especially after performing the search function.
- This unit cannot play back the following files:
  - MP3 files encoded with MP3i and MP3 PRO format.
  - MP3 files encoded in an unappropriated format.
  - MP3 files encoded with Layer 1/2.
  - WMA files encoded with lossless, professional, and voice format.
  - WMA files which are not based upon Windows Media® Audio.
  - WMA files copy-protected with DRM.
  - Files which have the data such as WAVE, ATRAC3, etc.
- The search function works but search speed is not constant.

*To be continued....*

## Changing the source

- If you change the source, playback also stops (without ejecting the disc).  
Next time you select “CD” or “CD-CH” for the playback source, disc play starts from where it has been stopped previously.

## Ejecting a disc

- If the ejected disc is not removed within 15 seconds, the disc is automatically inserted again into the loading slot to protect it from dust. (Disc will not play this time.)

## Tape operations

### Playing a tape

- While locating a specified tune:
  - If the tape is rewound to its beginning, playback starts from the beginning of that side.
  - If the tape is fast-forwarded to the end, it is reversed and played from the beginning of the other side.
- In the following cases, Multi Music Scan (MMS), Blank Skip, and Repeat Play may not operate correctly:
  - Tapes with tunes having long pianissimo passages (very quiet parts) or non-recorded portions.
  - Tapes with short non-recorded sections.
  - Tapes with high level noise or humming between tunes.
  - The Dolby NR setting does not match. For example, if the tape is recorded with the Dolby C NR.
- Do not use the following tape:
  - Dirty or dusty tapes.
  - Cassette with peeling labels.
  - Loose tape which may become entangled with the mechanism.

## Changing the source

- If you change the source, playback also stops (without ejecting the cassette).

## Ignition key-off release

- When you turn off the ignition key with a cassette in the compartment, the unit automatically releases the tape from its head.

## General settings—PSM

- If you change the “TAG DISP” setting from “TAG OFF” to “TAG ON” while playing MP3/WMA file, the tag display will be activated when the next file starts playing.
- If you change the “AMP GAIN” setting from “HIGH PWR” to “LOW PWR” while the volume level is set higher than “VOLUME 30,” the unit automatically changes the volume level to “VOLUME 30.”

## Other main functions

- If you try to assign a title to the 31st station frequency, “NAME FULL” flashes. Delete unwanted titles before assignment.



# Troubleshooting

What appears to be trouble is not always serious. Check the following points before calling a service center.

	Symptoms	Remedies/Causes
General	<ul style="list-style-type: none"> <li>• Sound cannot be heard from the speakers.</li> </ul>	<ul style="list-style-type: none"> <li>• Adjust the volume to the optimum level.</li> <li>• Check the cords and connections.</li> </ul>
	<ul style="list-style-type: none"> <li>• The unit does not work at all.</li> </ul>	Reset the unit (see page 2).
FM/AM	<ul style="list-style-type: none"> <li>• SSM automatic presetting does not work.</li> </ul>	Store stations manually.
	<ul style="list-style-type: none"> <li>• Static noise while listening to the radio.</li> </ul>	Connect the antenna firmly.
Disc playback	<ul style="list-style-type: none"> <li>• Disc cannot be played back.</li> </ul>	Insert the disc correctly.
	<ul style="list-style-type: none"> <li>• CD-R/CD-RW cannot be played back.</li> <li>• Tracks on the CD-R/CD-RW cannot be skipped.</li> </ul>	<ul style="list-style-type: none"> <li>• Insert a finalized CD-R/CD-RW.</li> <li>• Finalize the CD-R/CD-RW with the component which you used for recording.</li> </ul>
	<ul style="list-style-type: none"> <li>• Disc can be neither played back nor ejected.</li> </ul>	<ul style="list-style-type: none"> <li>• Unlock the disc (see page 15).</li> <li>• Eject the disc forcibly (see page 2).</li> </ul>
	<ul style="list-style-type: none"> <li>• Disc sound is sometimes interrupted.</li> </ul>	<ul style="list-style-type: none"> <li>• Stop playback while driving on rough roads.</li> <li>• Use an unscratched disc.</li> <li>• Check the cords and connections.</li> </ul>
	<ul style="list-style-type: none"> <li>• “NO DISC” appears on the display.</li> </ul>	Insert a correct disc into the loading slot.
MP3/WMA playback	<ul style="list-style-type: none"> <li>• KW-TC111/KW-TC110 cannot play back MP3 or WMA discs in the unit.</li> <li>• KW-TC111/KW-TC110 can only control MP3 discs in an MP3-compatible CD changer.</li> </ul>	
	<ul style="list-style-type: none"> <li>• Disc cannot be played back.</li> </ul>	<ul style="list-style-type: none"> <li>• Use a disc with MP3/WMA tracks recorded in the format compliant with ISO 9660 Level 1, Level 2, Romeo, or Joliet.</li> <li>• Add the extension code &lt;.mp3&gt; or &lt;.wma&gt; to the file names.</li> </ul>
	<ul style="list-style-type: none"> <li>• Noise is generated.</li> </ul>	Skip to another track or change the disc. (Do not add the extension code <.mp3> or <.wma> to non-MP3 or WMA tracks.)
	<ul style="list-style-type: none"> <li>• A longer readout time is required (“CHECK” keeps flashing on the display).</li> </ul>	Do not use too many hierarchies and folders.

To be continued....

	Symptoms	Remedies/Causes
MP3/WMA playback	• Tracks do not play back in the order you have intended them to play.	Playback order is determined when the files are recorded.
	• Elapsed playing time is not correct.	This sometimes occurs during play. This is caused by how the tracks are recorded on the disc.
	• “NO FILES” appears on the display.	Insert a disc that contains MP3/WMA tracks.
	• Correct characters are not displayed (e.g. album name).	This unit can only display alphabets (upper/lower case), numbers, and a limited number of symbols.
Tape playback	• A cassette cannot be inserted.	Insert the cassette with the exposed tape facing right.
	• Cassette can be neither played back nor ejected.	Unlock the cassette (see page 17).
	• “NO TAPE” appears on the display.	Insert a cassette correctly.
	• Cassette tapes become hot.	This is not a malfunction.
	• Tape sound is at very low level and sound quality is degraded.	Clean the tape head using a head cleaning tape.
CD changer	• “NO DISC” appears on the display.	Insert a disc into the magazine.
	• “NO MAG” appears on the display.	Insert the magazine.
	• “RESET 8” appears on the display.	Connect this unit and the CD changer correctly and press the reset button of the CD changer.
	• “RESET 1” – “RESET 7” appears on the display.	Press the reset button of the CD changer.
	• The CD changer does not work at all.	Reset the unit (see page 2).

- Microsoft and Windows Media are either registered trademarks or trademarks of Microsoft Corporation in the United States and/or other countries.

# Specifications

## AUDIO AMPLIFIER SECTION

Maximum Power Output:

Front: 50 W per channel

Rear: 50 W per channel

Continuous Power Output (RMS):

Front: 19 W per channel into 4  $\Omega$ , 40 Hz to 20 000 Hz at no more than 0.8% total harmonic distortion.

Rear: 19 W per channel into 4  $\Omega$ , 40 Hz to 20 000 Hz at no more than 0.8% total harmonic distortion.

Load Impedance: 4  $\Omega$  (4  $\Omega$  to 8  $\Omega$  allowance)

Equalizer Control Range:

Low:  $\pm 12$  dB (60 Hz, 80 Hz, 100 Hz, 120 Hz)

Mid:  $\pm 12$  dB

High:  $\pm 12$  dB (8 kHz, 10 kHz, 12 kHz, 15 kHz)

Frequency Response: 40 Hz to 20 000 Hz

Signal-to-Noise Ratio: 70 dB

Line-Out Level/Impedance:

2.0 V/20 k $\Omega$  load (full scale)

Output Impedance: 1 k $\Omega$

Other terminals: CD changer, AUX (auxiliary) input jack

## TUNER SECTION

Frequency Range:

FM: 87.5 MHz to 108.0 MHz

AM: 531 kHz to 1 602 kHz

### [FM Tuner]

Usable Sensitivity: 11.3 dBf (1.0  $\mu$ V/75  $\Omega$ )

50 dB Quieting Sensitivity:

16.3 dBf (1.8  $\mu$ V/75  $\Omega$ )

Alternate Channel Selectivity (400 kHz): 65 dB

Frequency Response: 40 Hz to 15 000 Hz

Stereo Separation: 30 dB

Capture Ratio: 1.5 dB

### [AM Tuner]

Sensitivity: 20  $\mu$ V

Selectivity: 35 dB

## CD PLAYER SECTION

Type: Compact disc player

Signal Detection System: Non-contact optical pickup (semiconductor laser)

Number of Channels: 2 channels (stereo)

Frequency Response: 5 Hz to 20 000 Hz

Dynamic Range: 96 dB

Signal-to-Noise Ratio: 98 dB

Wow and Flutter: Less than measurable limit

KW-TC411/KW-TC410 only:

MP3 Decoding Format:

MPEG1/2 Audio Layer 3

Max. Bit Rate: 320 kbps

WMA (Windows Media<sup>®</sup> Audio) Decoding Format:

Max. Bit Rate: 192 kbps

## CASSETTE DECK SECTION

Wow and Flutter: 0.1 % (WRMS)

Fast-Wind Time: 100 sec. (C-60)

Frequency Response: 30 Hz to 16 000 Hz (Normal tape)

Signal-to-Noise Ratio: (Normal tape)

Dolby B NR ON: 65 dB

Dolby B NR OFF: 56 dB

Stereo Separation: 40 dB

## GENERAL

Power Requirement:

Operating Voltage:

DC 14.4 V (11 V to 16 V allowance)

Grounding System: Negative ground

Allowable Operating Temperature:

0°C to +40°C

Dimensions (W  $\times$  H  $\times$  D):

Installation Size (approx.):

178 mm  $\times$  100 mm  $\times$  158 mm

Set Size (approx.):

178 mm  $\times$  100 mm  $\times$  177 mm

Mass (approx.):

2.3 kg (excluding accessories)

*Design and specifications are subject to change without notice.*



**Having TROUBLE with operation?  
Please reset your unit**

Refer to page of How to reset your unit

**Ada MASALAH dengan cara  
pengoperasian?**

**Setel kembali unit Anda**

Lihat halaman mengenai Bagaimana mereset unit anda

**JVC**



EN, IN

© 2005 Victor Company of Japan, Limited

0905DTSMDTJEIN

# JVC

## SCHEMATIC DIAGRAMS

### CD/CASSETTE RECEIVER

# KW-TC410, KW-TC411

CD-ROM No.SML200512

Area suffix

UN ----- Indonesia

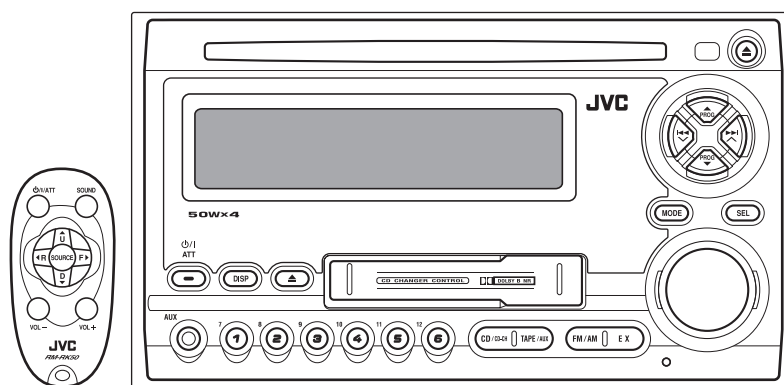

COMPACT  
disc  
DIGITAL AUDIO  
TEXT MP3 WMA

Lead free solder used in the board (material : Sn-Ag-Cu, melting point : 219 Centigrade)

### Contents

Block diagram .....	2-1
Standard schematic diagrams .....	2-2
Printed circuit boards .....	2-6 to 8

## Safety precaution



**CAUTION** Burrs formed during molding may be left over on some parts of the chassis. Therefore, pay attention to such burrs in the case of performing repair of this system.



**CAUTION** Please use enough caution not to see the beam directly or touch it in case of an adjustment or operation check.

# Block diagram

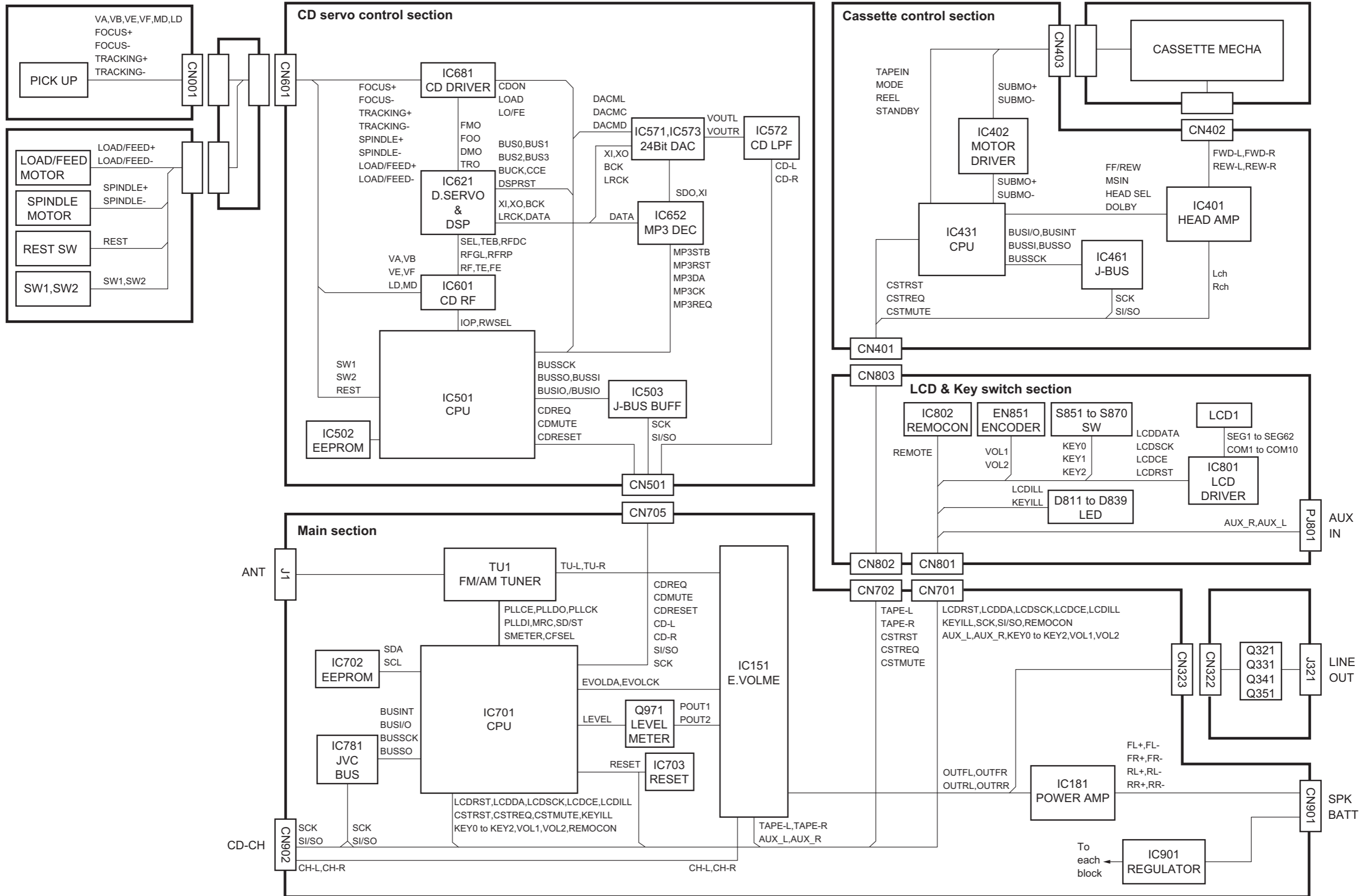

# Standard schematic diagrams ■ Main section

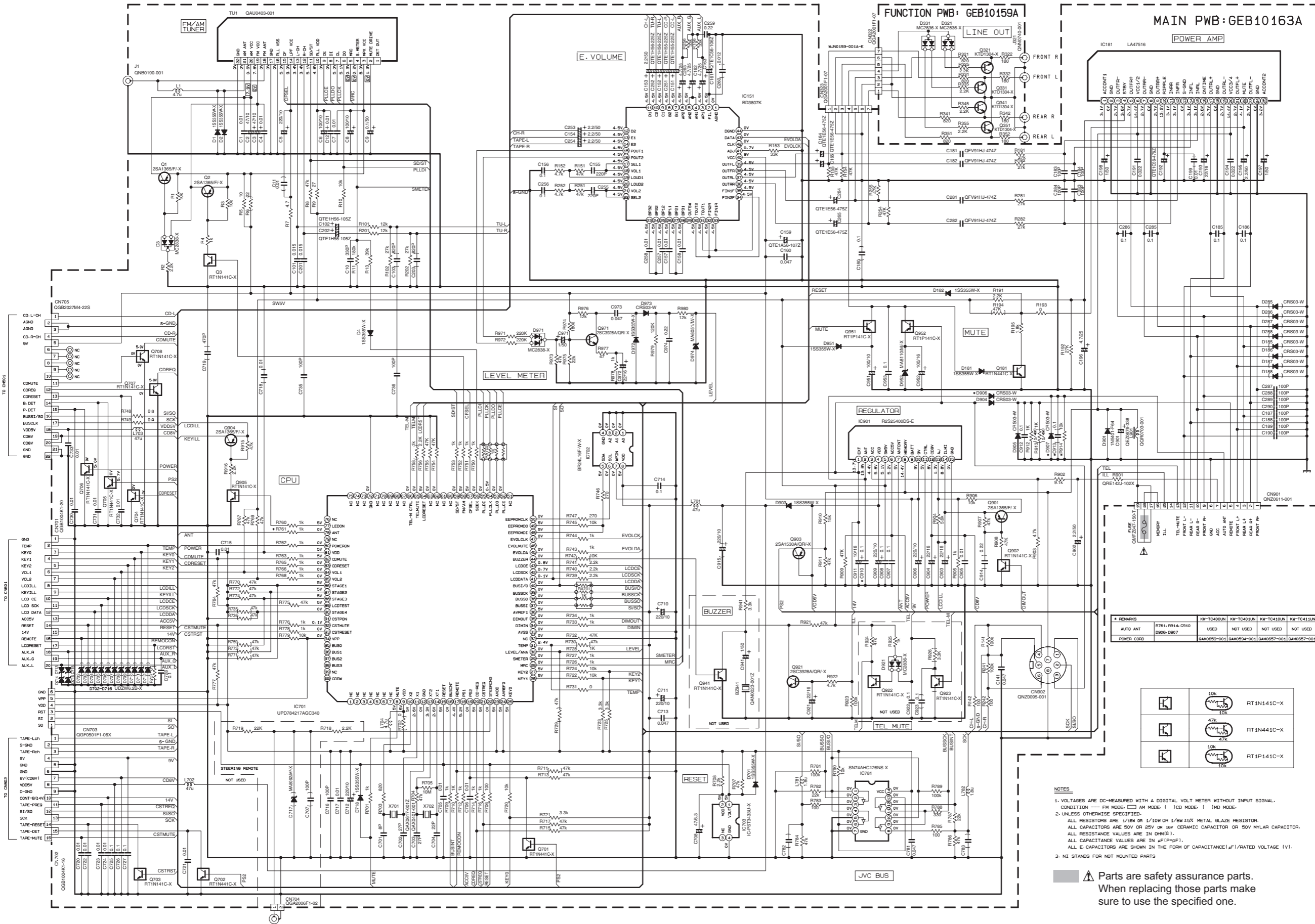

REMARKS	RW-TC400UN	RW-TC401UN	RW-TC410UN	RW-TC411UN
AUTO ANT	R761-R914-C910	USED	NOT USED	NOT USED
RESET	D906-D907	USED	NOT USED	NOT USED
POWER CORD	QAN0659-001	QAM0994-001	QAM0697-001	QAM0697-001

	10k	RT1N141C-X
	47k	RT1N441C-X
	10k	RT1P141C-X

- NOTES**
- VOLTAGES ARE DC-MEASURED WITH A DIGITAL VOLT METER WITHOUT INPUT SIGNAL.  
CONDITION — FM MODE: AM MODE: CD MODE: IMD MODE.
  - UNLESS OTHERWISE SPECIFIED.
  - ALL RESISTORS ARE 1/16W OR 1/10W OR 1/8W ±5% METAL GLAZE RESISTOR.  
ALL CAPACITORS ARE 50V OR 25V OR 16V CERAMIC CAPACITOR OR 50V MYLAR CAPACITOR.  
ALL RESISTANCE VALUES ARE IN OHMS (Ω).
  - ALL CAPACITANCE VALUES ARE IN μF (μF).
  - ALL E-CAPACITORS ARE SHOWN IN THE FORM OF CAPACITANCE (μF)/RATED VOLTAGE (V).
  3. NI STANDS FOR NOT MOUNTED PARTS

**Parts are safety assurance parts.**  
When replacing those parts make sure to use the specified one.





■ Cassette section

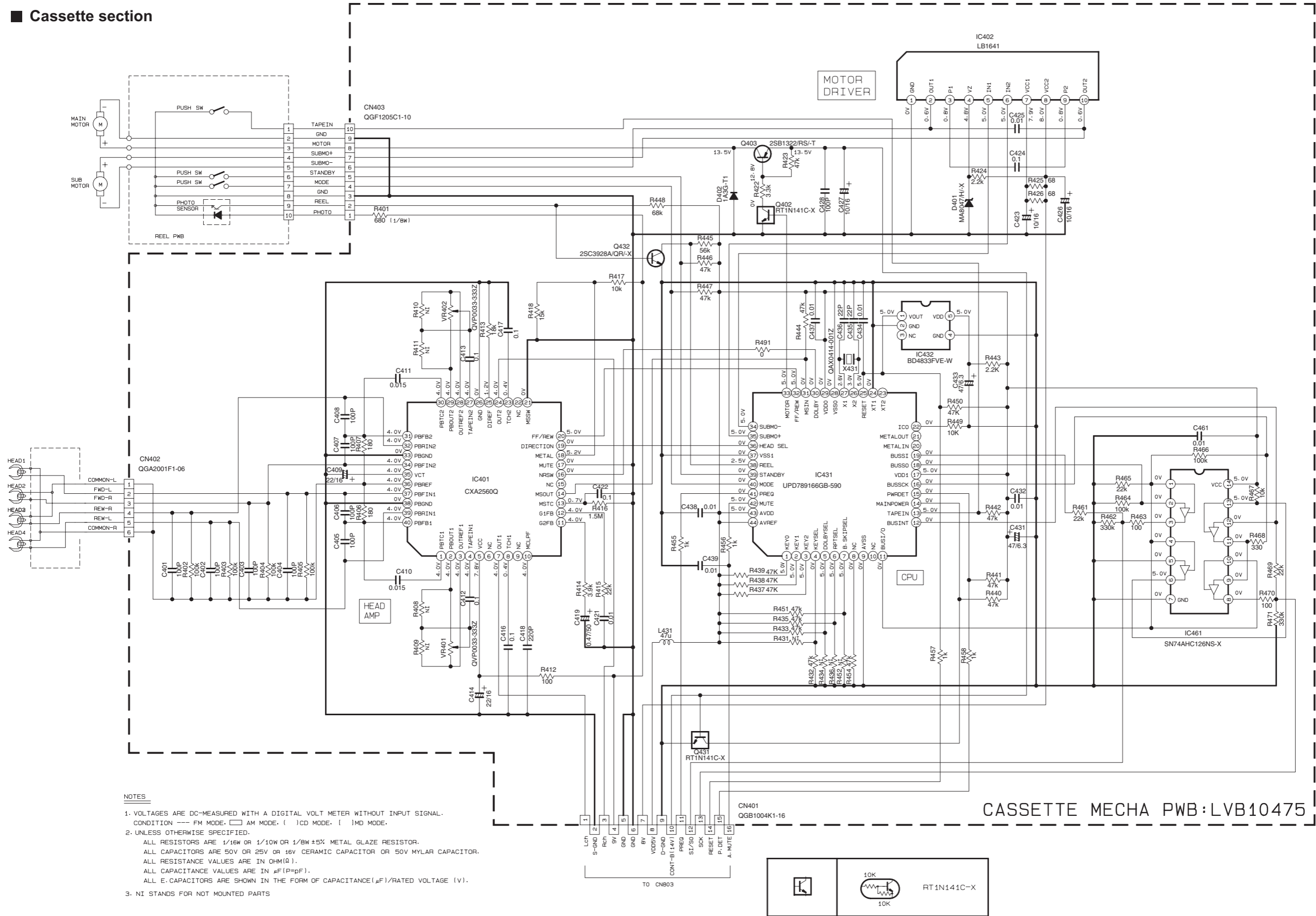

■ LCD & Key control section

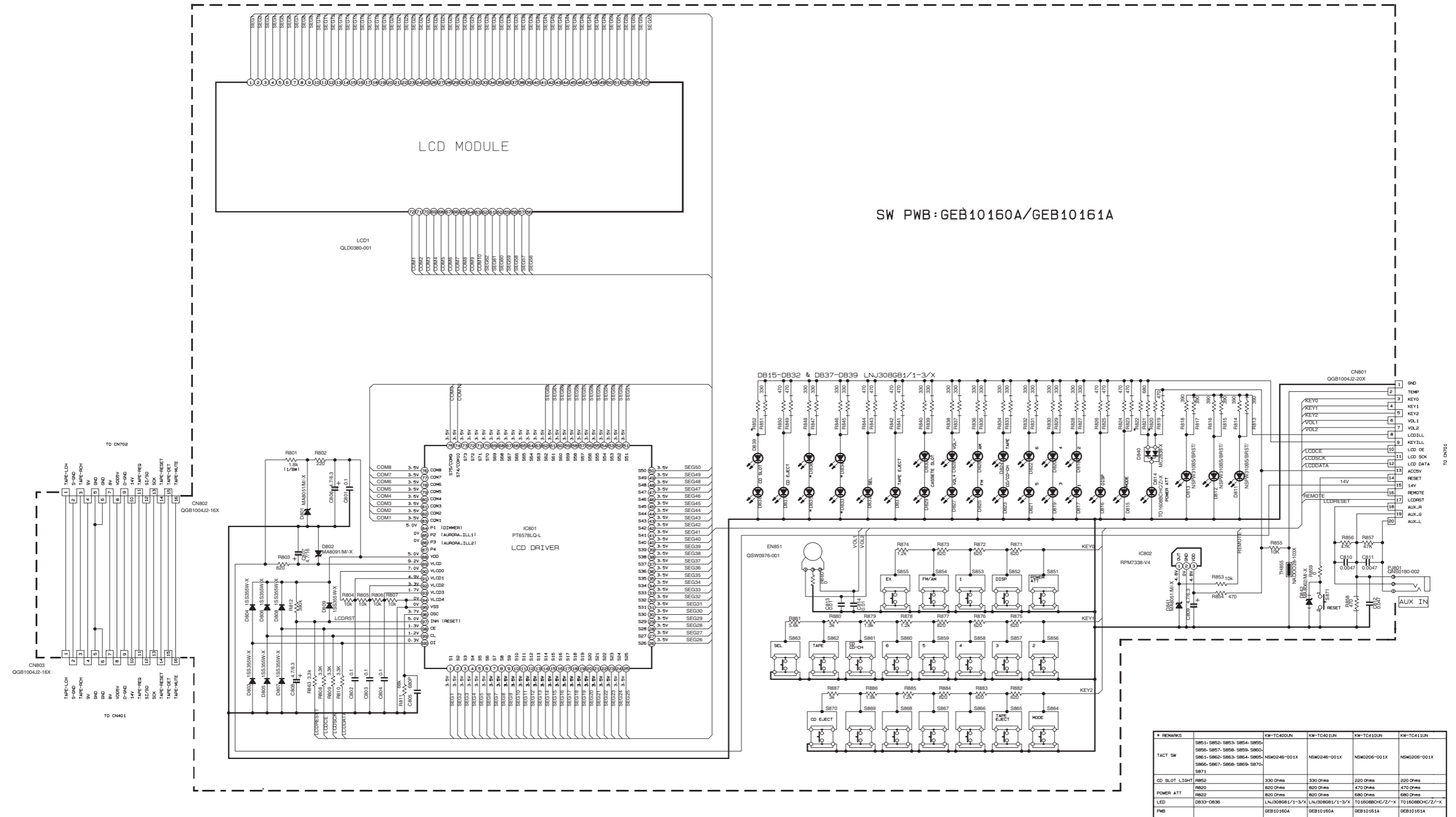

NOTES

- VOLTAGES ARE DC-MEASURED WITH A DIGITAL VOLT METER WITHOUT INPUT SIGNAL. CONDITION --- FM MODE. ( ) AM MODE. ( ) CD MODE. ( ) TAPE MODE.
- UNLESS OTHERWISE SPECIFIED, ALL RESISTORS ARE 1/4W OR 1/10W OR 1/8W 45% METAL GLAZE RESISTOR. ALL CAPACITORS ARE 50V OR 25V OR 16V 45% CERAMIC CAPACITOR OR 50V MYLAR CAPACITOR. ALL RESISTANCE VALUES ARE IN OHM(Ω). ALL CAPACITANCE VALUES ARE IN #F(P+PF). ALL E. CAPACITORS ARE SHOWN IN THE FORM OF CAPACITANCE (#F1/RATED VOLTAGE (V)).
- NI STANDS FOR NOT MOUNTED PARTS





■ **Cassette board**

Lead free solder used in the board (material : Sn-Ag-Cu, melting point : 219 Centigrade)

Forward side

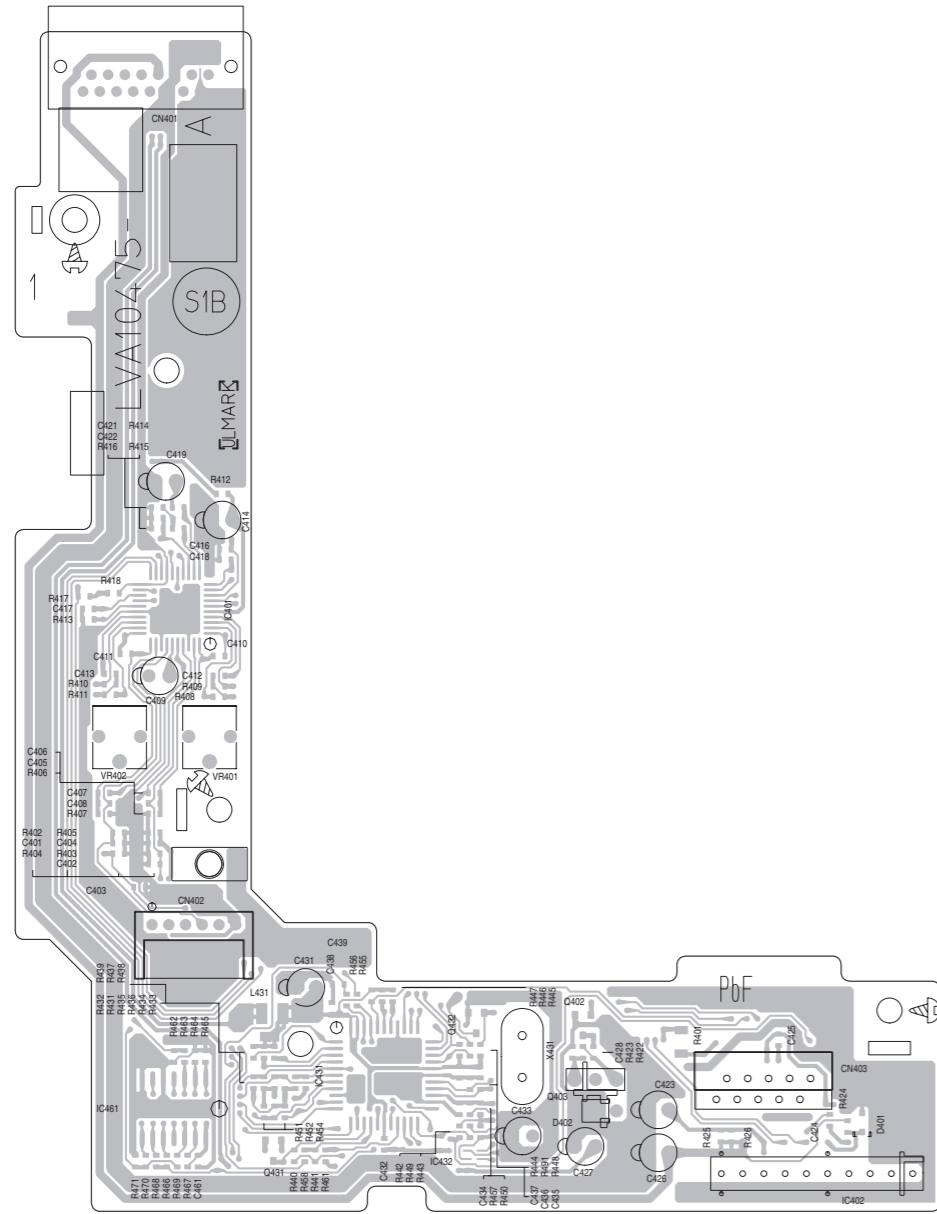

Reverse side

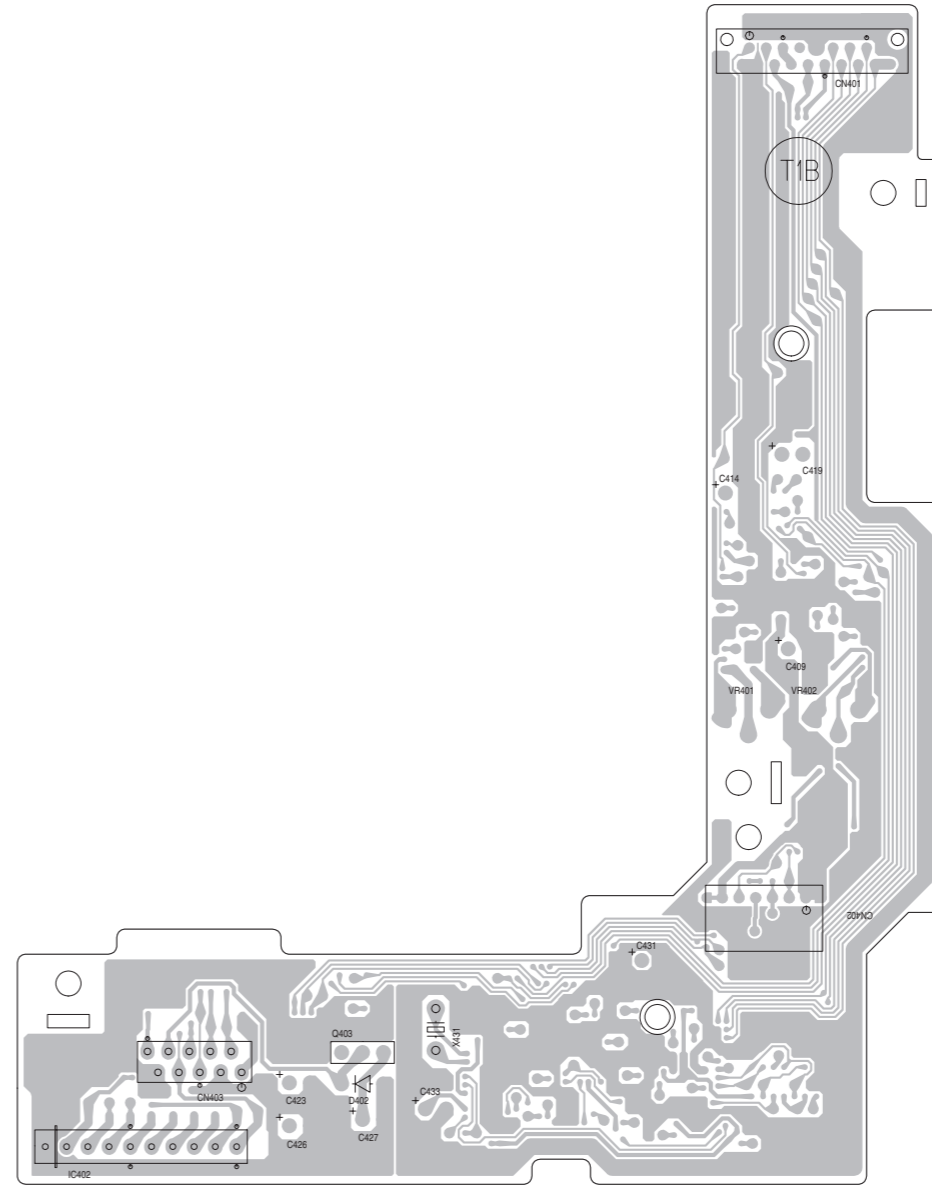

■ **Function board**

Lead free solder used in the board (material : Sn-Ag-Cu, melting point : 219 Centigrade)

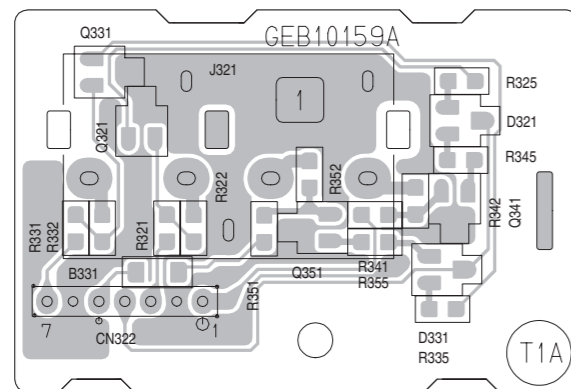

< MEMO >

**JVC**

**Victor Company of Japan, Limited**

Mobile Entertainment Business Group Mobile Entertainment Category 10-1, 1chome, Ohwatari-machi, Maebashi-city, 371-8543, Japan

(No.MA244SCH)



Printed in Japan  
VPT



# PARTS LIST

[ KW-TC410 ] [ KW-TC411 ]

\* All printed circuit boards and its assemblies are not available as service parts.

<b>KW-TC410, KW-TC411</b>
Area suffix
UN ----- Indonesia

## - Contents -

Exploded view of general assembly and parts list (Block No.M1)-----	3-2
Electrical parts list (Block No.01~05) -----	3-5
Packing materials and accessories parts list (Block No.M3)-----	3-12

# Exploded view of general assembly and parts list

Block No. **M 1 M M**

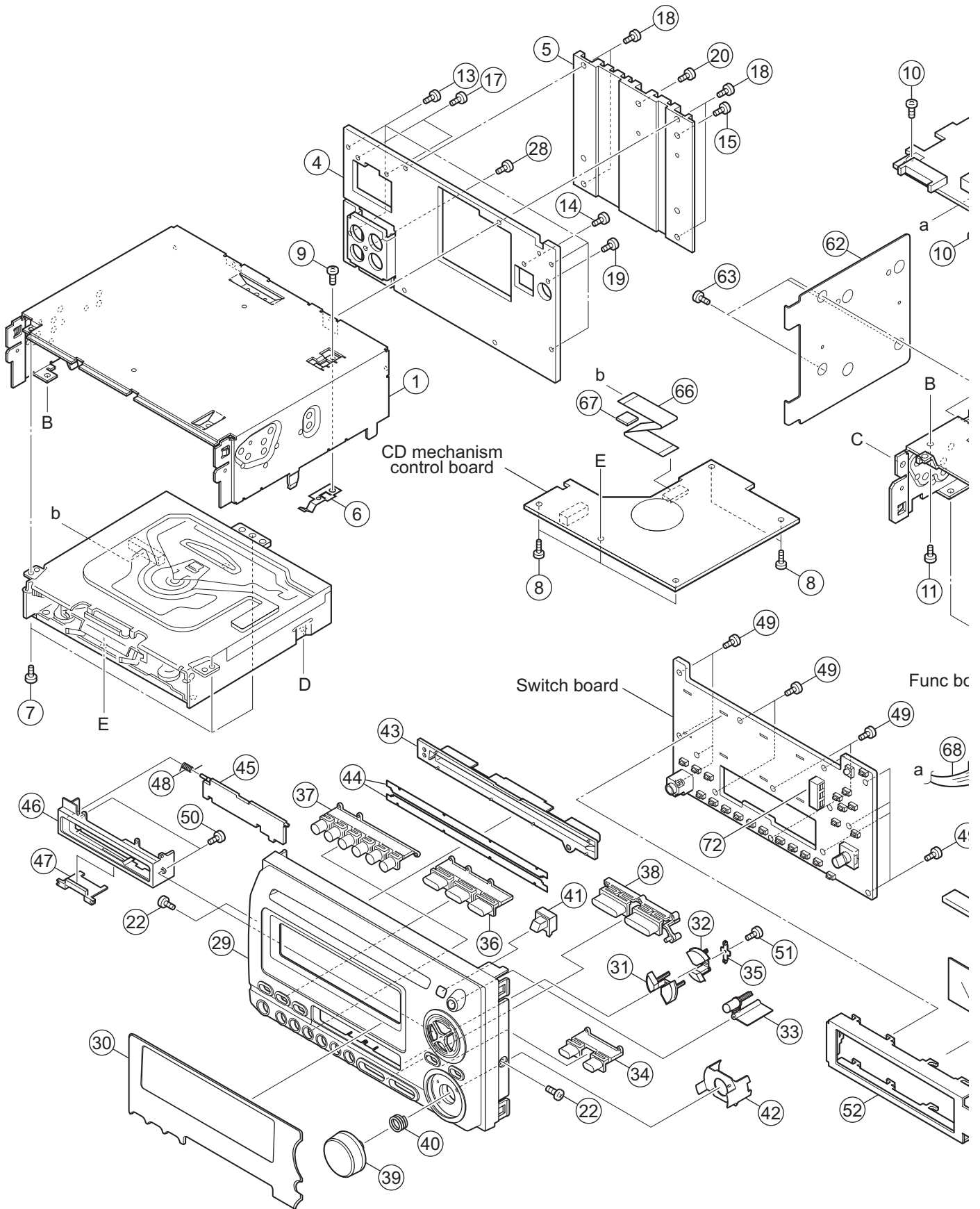

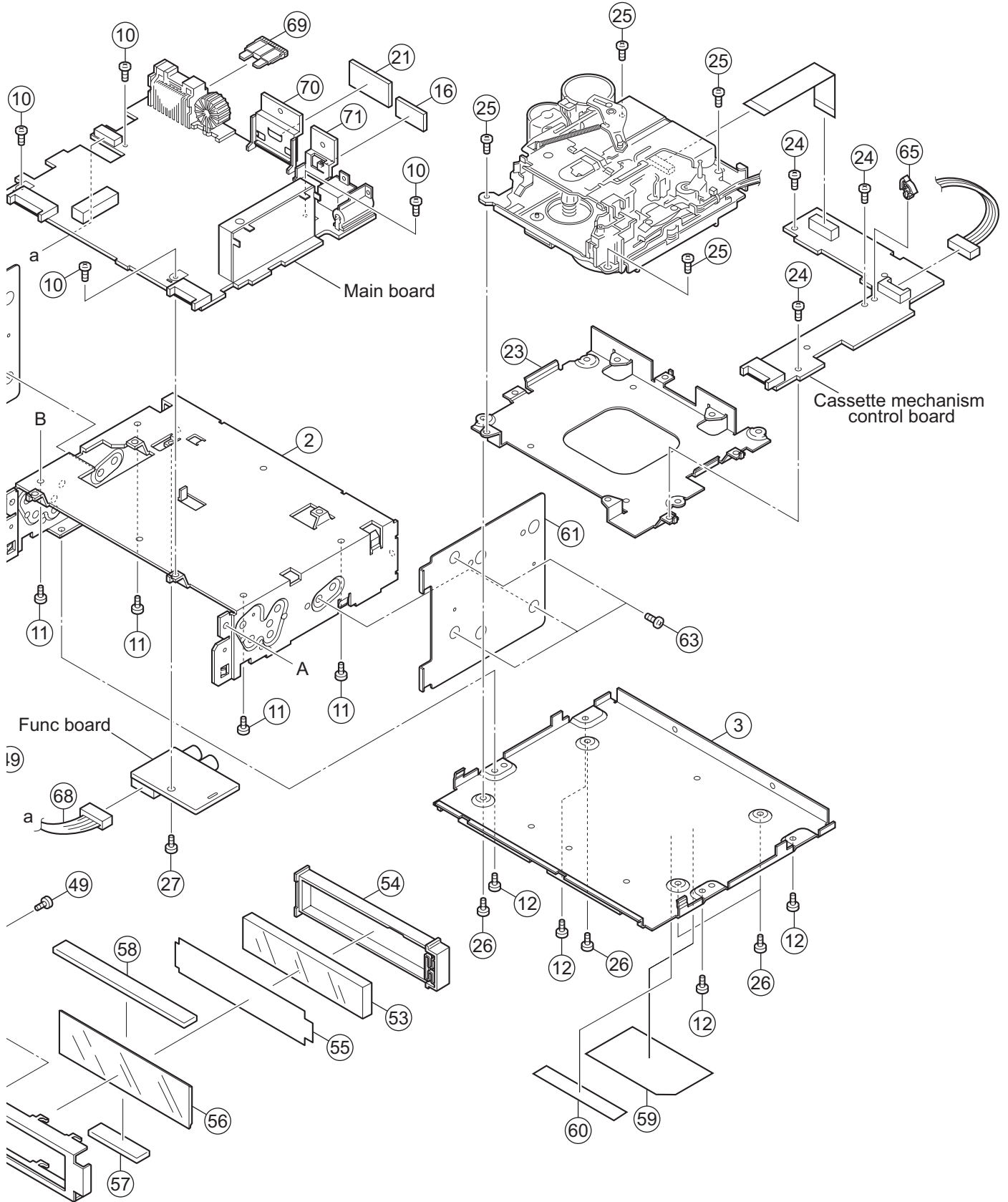

# General Assembly

Block No. [M][1][M][M]

△	Symbol No.	Part No.	Part Name	Description	Local
	1	LV10863-001A	TOP CHASSIS		
	2	LV10864-002A	MIDDLE CHASSIS		
	3	LV10865-001A	BOTTOM CHASSIS		
	4	GE31799-001A	REAR BRACKET		
	5	LV34655-001A	HEAT SINK		
	6	LV34654-001A	EARTH PLATE		
	7	QYSDST2604ZA	TAP SCREW	M2.6 x 4mm(x3)	
	8	QYSDST2004ZA	TAP SCREW	M2 x 4mm(x5)	
	9	QYSDST2606ZA	TAP SCREW	M2.6 x 6mm	
	10	GE40235-004A	SCREW	(x4)	
	11	QYSDST2606ZA	TAP SCREW	M2.6 x 6mm(x4)	
	12	QYSDST2606ZA	TAP SCREW	M2.6 x 6mm(x4)	
	13	QYSDST2606ZA	TAP SCREW	M2.6 x 6mm(x4)	
	14	QYSDST2606ZA	TAP SCREW	M2.6 x 6mm	
	15	QYSDST2606ZA	TAP SCREW	M2.6 x 6mm	
	16	LV43693-001A	COOLING RUBBER		
	17	QYSDSF2606ZA	TAP SCREW	M2.6 x 6mm(x2)	
	18	QYSDST2606ZA	TAP SCREW	M2.6 x 6mm(x4)	
	19	QYSDST2606ZA	TAP SCREW	M2.6 x 6mm	
	20	QYSDST2606ZA	TAP SCREW	M2.6 x 6mm	
	21	LV43694-001A	COOLING RUBBER		
	22	QYSDST2004ZA	TAP SCREW	M2 x 4mm(x2)	
	23	LV21628-001A	CS MECHA BKT		
	24	QYSDST2606ZA	TAP SCREW	M2.6 x 6mm(x3)	
	25	QYSDST2606ZA	TAP SCREW	M2.6 x 6mm(x4)	
	26	QYSDST2606ZA	TAP SCREW	M2.6 x 6mm(x4)	
	27	QYSDST2606ZA	TAP SCREW	M2.6 x 6mm	
	28	QYSDSF3006ZA	TAP SCREW	M3 x 6mm	
	29	GE10128-001A	FRONT PANEL		
	30	GE31803-001A	FINDER ASSY		TC410
	30	GE31803-003A	FINDER ASSY		TC411
	31	GE31766-001A	SEARCH BTN		
	32	GE31765-001A	UP/DOWN BTN		
	33	GE31759-001A	CD EJECT BTN		
	34	GE31762-001A	DISP/SEL BTN		
	35	LV43181-002A	4WAY BUTTON BAS		
	36	GE31760-001A	POWER/EJECT BTN		
	37	GE20186-001A	PRESET BTN		
	38	GE31761-001A	D.FUNCTION BTN		
	39	GE31763-001A	VOLUME KNOB		
	40	GE40127-001A	KNOB SPRING		
	41	GE40287-001A	REMOTE LENS		
	42	GE31764-001A	RIM LENS		
	43	GE31758-001A	CD GUIDE		
	44	GE40286-001A	CD BLIND	(x2)	
	45	GE31775-001A	CASS.LID		
	46	GE31767-001A	CASS.GUIDE		
	47	GE40289-001A	CASS.LENS		
	48	VKW5312-001	DOOR SPRING		
	49	VKZ4777-010	MINI SCREW	(x13)	
	50	VKZ4777-011	MINI SCREW	(x2)	
	51	VKZ4777-010	MINI SCREW		
	52	GE31771-001A	LCD CASE		
	53	GE31773-001A	LCD LENS		
	54	GE31772-001A	LENS CASE		
	55	GE40285-001A	LIGHTING SHEET		
	56	QLD0380-001	LCD MODULE		
	57	QNZ0817-001	RUBBER CONNECTO		
	58	QNZ0818-001	RUBBER CONNECTO		
	59	GE31789-002A	NAME PLATE		TC410
	59	GE31791-002A	NAME PLATE		TC411
	60	LV41843-002A	LASER CAUTION		
	61	LV42375-005A	BRACKET R		
	62	LV42376-005A	BRACKET L		
	63	QYSSP5008ZA	SCREW	M5 x 8mm(x6)	
	65	QZW0143-001	WIRE CLAMP		
	66	QUQ105-2207AE-E	FFC WIRE	22pin 7cm	
	67	VYSH101-009	SPACER		
	68	WJN0193-001A-E	E-SH C WIRE C-C		
△	69	QMFZ047-150-T	FUSE	15A	
	70	LV34650-001A	IC BKT		
	71	LV34651-001A	REG BKT		
	72	GE31774-001A	LED HOLDER		

# Electrical parts list

## Main board

Block No. [0][1]

△ Symbol No.	Part No.	Part Name	Description	Local
IC151	BD3807K	IC		
IC181	LA47516	POWER IC		
IC701	UPD784217AGC340	IC		
IC702	BR24L16F-W-X	IC		
IC703	S-80833CNNB-G-W	IC		
IC781	SN74AHC126NS-X	IC		
IC901	R2S25400DS-E	REGULATOR IC		
Q1	2SA1365/F/-X	TRANSISTOR		
Q2	2SA1365/F/-X	TRANSISTOR		
Q3	RT1N141C-X	DIGI TRANSISTOR		
Q181	RT1N441C-X	TRANSISTOR		
Q701	RT1N441C-X	TRANSISTOR		
Q702	RT1N441C-X	TRANSISTOR		
Q703	RT1N141C-X	DIGI TRANSISTOR		
Q704	RT1N141C-X	DIGI TRANSISTOR		
Q705	RT1N441C-X	TRANSISTOR		
Q706	RT1N141C-X	DIGI TRANSISTOR		
Q707	RT1N141C-X	DIGI TRANSISTOR		
Q708	RT1N141C-X	DIGI TRANSISTOR		
Q901	2SA1365/F/-X	TRANSISTOR		
Q902	RT1N141C-X	DIGI TRANSISTOR		
Q903	2SA1530A/QR/-X	TRANSISTOR		
Q904	2SA1365/F/-X	TRANSISTOR		
Q905	RT1N141C-X	DIGI TRANSISTOR		
Q921	2SC3928A/QR/-X	TRANSISTOR		
Q951	RT1P141C-X	DIGI TRANSISTOR		
Q952	RT1P141C-X	DIGI TRANSISTOR		
Q971	2SC3928A/QR/-X	TRANSISTOR		
D1	1SS355W-X	DIODE C.M		
D2	1SS355W-X	DIODE C.M		
D3	MC2838-X	DIODE		
D4	1SS355W-X	DIODE C.M		
D181	1SS355W-X	DIODE C.M		
D182	1SS355W-X	DIODE C.M		
D701	1SS355W-X	DIODE C.M		
D713	UDZW6.2B-X	DIODE		
D714	UDZW6.2B-X	DIODE		
D715	UDZW6.2B-X	DIODE		
D716	UDZW6.2B-X	DIODE		
D718	1SS355W-X	DIODE C.M		
D901	1N5401-F64	DIODE		
D903	1SS355W-X	DIODE C.M		
D904	CRS03-W	SB DIODE		
D905	CRS03-W	SB DIODE		
D951	1SS355W-X	DIODE C.M		
D952	UDZW11B-X	Z DIODE		
D971	MC2838-X	DIODE		
D972	1SS355W-X	DIODE C.M		
D973	CRS03-W	SB DIODE		
D974	UDZW5.1B-X	SI DIODE		
C1	NCB31HK-103X	C CAPACITOR	0.01uF 50V K	
C2	QERF1AM-476Z	E CAPACITOR	47uF 10V M	
C3	QERF1AM-476Z	E CAPACITOR	47uF 10V M	
C4	NCB31HK-103X	C CAPACITOR	0.01uF 50V K	
C5	QERF1AM-227Z	E CAPACITOR	220uF 10V M	
C6	QERF1AM-107Z	E CAPACITOR	100uF 10V M	
C7	NCB31HK-103X	C CAPACITOR	0.01uF 50V K	
C8	QERF1AM-107Z	E CAPACITOR	100uF 10V M	
C9	QERF1HM-104Z	E CAPACITOR	0.1uF 50V M	
C10	NCS31HJ-331X	C CAPACITOR	330pF 50V J	
C12	NCB31HK-103X	C CAPACITOR	0.01uF 50V K	
C101	NCB31HK-153X	C CAPACITOR	0.015uF 50V K	
C102	QTE1H56-105Z	E CAPACITOR	1uF 50V	
C141	NCB31CK-473X	C CAPACITOR	0.047uF 16V K	
C151	QTE1H55-225Z	E CAPACITOR	2.2uF 50V	
C152	QTE1H56-225Z	E CAPACITOR	2.2uF 50V	
C153	QERF1HM-225Z	E CAPACITOR	2.2uF 50V M	
C154	QERF1HM-225Z	E CAPACITOR	2.2uF 50V M	
C155	NCB31HK-221X	C CAPACITOR	220pF 50V K	

△ Symbol No.	Part No.	Part Name	Description	Local
C156	NCB31CK-104X	C CAPACITOR	0.1uF 16V K	
C157	NCB31HK-103X	C CAPACITOR	0.01uF 50V K	
C158	NCB31HK-103X	C CAPACITOR	0.01uF 50V K	
C159	QTE1A56-107Z	E CAPACITOR	100uF 10V	
C160	NCB31CK-473X	C CAPACITOR	0.047uF 16V K	
C161	QTE1C56-106Z	E CAPACITOR	10uF 16V	
C162	QERF1EM-475Z	E CAPACITOR	4.7uF 25V M	
C163	QERF1EM-475Z	E CAPACITOR	4.7uF 25V M	
C164	QTE1E56-475Z	E CAPACITOR	4.7uF 25V	
C165	QTE1E56-475Z	E CAPACITOR	4.7uF 25V	
C181	QFV91HJ-474Z	MF CAPACITOR	0.47uF 50V J	
C182	QFV91HJ-474Z	MF CAPACITOR	0.47uF 50V J	
C183	NDC31HJ-101X	C CAPACITOR	100pF 50V J	
C184	NDC31HJ-101X	C CAPACITOR	100pF 50V J	
C185	NCB31CK-104X	C CAPACITOR	0.1uF 16V K	
C186	NCB31CK-104X	C CAPACITOR	0.1uF 16V K	
C187	NDC31HJ-101X	C CAPACITOR	100pF 50V J	
C188	NDC31HJ-101X	C CAPACITOR	100pF 50V J	
C189	NDC31HJ-101X	C CAPACITOR	100pF 50V J	
C190	NDC31HJ-101X	C CAPACITOR	100pF 50V J	
C191	NCB31HK-223X	C CAPACITOR	0.022uF 50V K	
C192	QTE1C56-476Z	E CAPACITOR	47uF 16V	
C193	QERF1CM-226Z	E CAPACITOR	22uF 16V M	
C194	NCB31HK-223X	C CAPACITOR	0.022uF 50V K	
C195	QERF1HM-225Z	E CAPACITOR	2.2uF 50V M	
C196	QERF1EM-475Z	E CAPACITOR	4.7uF 25V M	
C197	QERF1HM-105Z	E CAPACITOR	1uF 50V M	
C198	QERF1HM-105Z	E CAPACITOR	1uF 50V M	
C201	NCB31HK-153X	C CAPACITOR	0.015uF 50V K	
C202	QTE1H56-105Z	E CAPACITOR	1uF 50V	
C251	QTE1H55-225Z	E CAPACITOR	2.2uF 50V	
C252	QTE1H56-225Z	E CAPACITOR	2.2uF 50V	
C253	QERF1HM-225Z	E CAPACITOR	2.2uF 50V M	
C254	QERF1HM-225Z	E CAPACITOR	2.2uF 50V M	
C255	NCB31HK-221X	C CAPACITOR	220pF 50V K	
C256	NCB31CK-104X	C CAPACITOR	0.1uF 16V K	
C257	NCB31HK-103X	C CAPACITOR	0.01uF 50V K	
C258	NCB31HK-103X	C CAPACITOR	0.01uF 50V K	
C259	NCB31CK-224X	C CAPACITOR	0.22uF 16V K	
C263	QERF1EM-475Z	E CAPACITOR	4.7uF 25V M	
C264	QTE1E56-475Z	E CAPACITOR	4.7uF 25V	
C265	QTE1E56-475Z	E CAPACITOR	4.7uF 25V	
C281	QFV91HJ-474Z	MF CAPACITOR	0.47uF 50V J	
C282	QFV91HJ-474Z	MF CAPACITOR	0.47uF 50V J	
C283	NDC31HJ-101X	C CAPACITOR	100pF 50V J	
C284	NDC31HJ-101X	C CAPACITOR	100pF 50V J	
C285	NCB31CK-104X	C CAPACITOR	0.1uF 16V K	
C286	NCB31CK-104X	C CAPACITOR	0.1uF 16V K	
C287	NDC31HJ-101X	C CAPACITOR	100pF 50V J	
C288	NDC31HJ-101X	C CAPACITOR	100pF 50V J	
C289	NDC31HJ-101X	C CAPACITOR	100pF 50V J	
C290	NDC31HJ-101X	C CAPACITOR	100pF 50V J	
C701	NDC31HJ-8R0X	C CAPACITOR	8pF 50V J	
C702	NDC31HJ-270X	C CAPACITOR	27pF 50V J	
C703	NDC31HJ-270X	C CAPACITOR	27pF 50V J	
C704	NDC31HJ-220X	C CAPACITOR	22pF 50V J	
C705	NCB31HK-103X	C CAPACITOR	0.01uF 50V K	
C706	NCB31HK-103X	C CAPACITOR	0.01uF 50V K	
C708	QERF0JM-476Z	E CAPACITOR	47uF 6.3V M	
C710	QERF1AM-227Z	E CAPACITOR	220uF 10V M	
C711	QERF1AM-227Z	E CAPACITOR	220uF 10V M	
C712	QERF1AM-227Z	E CAPACITOR	220uF 10V M	
C713	NCB31CK-473X	C CAPACITOR	0.047uF 16V K	
C714	NCB31CK-104X	C CAPACITOR	0.1uF 16V K	
C715	NCB31HK-103X	C CAPACITOR	0.01uF 50V K	
C716	NDC31HJ-101X	C CAPACITOR	100pF 50V J	
C717	NCB31HK-103X	C CAPACITOR	0.01uF 50V K	
C720	NCB31HK-103X	C CAPACITOR	0.01uF 50V K	
C721	NCB31HK-103X	C CAPACITOR	0.01uF 50V K	
C722	NCB31HK-103X	C CAPACITOR	0.01uF 50V K	
C723	NCB31HK-103X	C CAPACITOR	0.01uF 50V K	
C724	NCB31HK-103X	C CAPACITOR	0.01uF 50V K	
C725	NCB31CK-104X	C CAPACITOR	0.1uF 16V K	
C726	NCB31CK-104X	C CAPACITOR	0.1uF 16V K	
C727	NCB31CK-104X	C CAPACITOR	0.1uF 16V K	
C728	NCB31CK-104X	C CAPACITOR	0.1uF 16V K	

△ Symbol No.	Part No.	Part Name	Description	Local	△ Symbol No.	Part No.	Part Name	Description	Local
C730	NCB31HK-103X	C CAPACITOR	0.01uF 50V K		R716	NRSA63J-102X	MG RESISTOR	1kΩ 1/16W J	
C731	NCB31HK-103X	C CAPACITOR	0.01uF 50V K		R717	NRSA63J-473X	MG RESISTOR	47kΩ 1/16W J	
C732	NCB31HK-103X	C CAPACITOR	0.01uF 50V K		R720	NRSA63J-103X	MG RESISTOR	10kΩ 1/16W J	
C733	NCB31HK-103X	C CAPACITOR	0.01uF 50V K		R721	NRSA63J-332X	MG RESISTOR	3.3kΩ 1/16W J	
C735	NDC31HJ-101X	C CAPACITOR	100pF 50V J		R722	NRSA63J-103X	MG RESISTOR	10kΩ 1/16W J	
C736	NDC31HJ-101X	C CAPACITOR	100pF 50V J		R723	NRSA63J-332X	MG RESISTOR	3.3kΩ 1/16W J	
C781	NCB31CK-473X	C CAPACITOR	0.047uF 16V K		R724	NRSA63J-103X	MG RESISTOR	10kΩ 1/16W J	
C901	QEZO676-338	E CAPACITOR	3300uF		R725	NRSA63J-332X	MG RESISTOR	3.3kΩ 1/16W J	
C902	QERF1HM-225Z	E CAPACITOR	2.2uF 50V M		R726	NRSA63J-102X	MG RESISTOR	1kΩ 1/16W J	
C903	QERF1CM-226Z	E CAPACITOR	22uF 16V M		R727	NRSA63J-102X	MG RESISTOR	1kΩ 1/16W J	
C904	QERF1CM-226Z	E CAPACITOR	22uF 16V M		R728	NRSA63J-102X	MG RESISTOR	1kΩ 1/16W J	
C905	NCB31HK-103X	C CAPACITOR	0.01uF 50V K		R731	NRSA63J-0R0X	MG RESISTOR	0Ω 1/16W J	
C906	QERF1AM-227Z	E CAPACITOR	220uF 10V M		R732	NRSA63J-473X	MG RESISTOR	47kΩ 1/16W J	
C907	NCB31CK-104X	C CAPACITOR	0.1uF 16V K		R733	NRSA63J-102X	MG RESISTOR	1kΩ 1/16W J	
C908	NCB31CK-104X	C CAPACITOR	0.1uF 16V K		R734	NRSA63J-102X	MG RESISTOR	1kΩ 1/16W J	
C909	QERF1AM-227Z	E CAPACITOR	220uF 10V M		R739	NRSA63J-222X	MG RESISTOR	2.2kΩ 1/16W J	
C911	QERF1CM-106Z	E CAPACITOR	10uF 16V M		R740	NRSA63J-222X	MG RESISTOR	2.2kΩ 1/16W J	
C912	NCB31CK-104X	C CAPACITOR	0.1uF 16V K		R741	NRSA63J-222X	MG RESISTOR	2.2kΩ 1/16W J	
C921	QERF1CM-226Z	E CAPACITOR	22uF 16V M		R743	NRSA63J-102X	MG RESISTOR	1kΩ 1/16W J	
C951	QERF1AM-107Z	E CAPACITOR	100uF 10V M		R744	NRSA63J-102X	MG RESISTOR	1kΩ 1/16W J	
C952	QERF1CM-107Z	E CAPACITOR	100uF 16V M		R745	NRSA63J-103X	MG RESISTOR	10kΩ 1/16W J	
C953	NCB31CK-104X	C CAPACITOR	0.1uF 16V K		R746	NRSA63J-271X	MG RESISTOR	270Ω 1/16W J	
C971	QERF1HM-105Z	E CAPACITOR	1uF 50V M		R747	NRSA63J-271X	MG RESISTOR	270Ω 1/16W J	
C972	QERF1CM-226Z	E CAPACITOR	22uF 16V M		R748	NRSA63J-0R0X	MG RESISTOR	0Ω 1/16W J	
C973	NCB31EK-473X	C CAPACITOR	0.047uF 25V K		R749	NRSA63J-0R0X	MG RESISTOR	0Ω 1/16W J	
C974	NCB31CK-224X	C CAPACITOR	0.22uF 16V K		R750	NRSA63J-102X	MG RESISTOR	1kΩ 1/16W J	
R1	NRSA63J-103X	MG RESISTOR	10kΩ 1/16W J		R751	NRSA63J-102X	MG RESISTOR	1kΩ 1/16W J	
R2	NRSA63J-222X	MG RESISTOR	2.2kΩ 1/16W J		R752	NRSA63J-102X	MG RESISTOR	1kΩ 1/16W J	
R3	NRSA63J-103X	MG RESISTOR	10kΩ 1/16W J		R753	NRSA63J-102X	MG RESISTOR	1kΩ 1/16W J	
R4	NRSA63J-102X	MG RESISTOR	1kΩ 1/16W J		R754	NRSA63J-473X	MG RESISTOR	47kΩ 1/16W J	
R5	NRS181J-100X	MG RESISTOR	10Ω 1/8W J		R755	NRSA63J-473X	MG RESISTOR	47kΩ 1/16W J	
R7	NRS181J-4R7X	MG RESISTOR	4.7Ω 1/8W J		R756	NRSA63J-222X	MG RESISTOR	2.2kΩ 1/16W J	
R8	NRSA63J-473X	MG RESISTOR	47kΩ 1/16W J		R760	NRSA63J-102X	MG RESISTOR	1kΩ 1/16W J	
R9	NRSA63J-270X	MG RESISTOR	27Ω 1/16W J		R762	NRSA63J-102X	MG RESISTOR	1kΩ 1/16W J	
R10	NRSA63J-103X	MG RESISTOR	10kΩ 1/16W J		R763	NRSA63J-102X	MG RESISTOR	1kΩ 1/16W J	
R11	NRSA63J-184X	MG RESISTOR	180kΩ 1/16W J		R764	NRSA63J-473X	MG RESISTOR	47kΩ 1/16W J	
R13	NRSA63J-393X	MG RESISTOR	39kΩ 1/16W J		R765	NRSA63J-102X	MG RESISTOR	1kΩ 1/16W J	
R101	NRSA63J-123X	MG RESISTOR	12kΩ 1/16W J		R766	NRSA63J-102X	MG RESISTOR	1kΩ 1/16W J	
R102	NRSA63J-273X	MG RESISTOR	27kΩ 1/16W J		R767	NRSA63J-473X	MG RESISTOR	47kΩ 1/16W J	
R141	NRSA63J-104X	MG RESISTOR	100kΩ 1/16W J		R768	NRSA63J-102X	MG RESISTOR	1kΩ 1/16W J	
R142	NRSA63J-101X	MG RESISTOR	100Ω 1/16W J		R769	NRSA63J-473X	MG RESISTOR	47kΩ 1/16W J	
R151	NRSA63J-473X	MG RESISTOR	47kΩ 1/16W J		R770	NRSA63J-473X	MG RESISTOR	47kΩ 1/16W J	
R152	NRSA63J-472X	MG RESISTOR	4.7kΩ 1/16W J		R772	NRSA63J-473X	MG RESISTOR	47kΩ 1/16W J	
R153	NRSA63J-333X	MG RESISTOR	33kΩ 1/16W J		R774	NRSA63J-473X	MG RESISTOR	47kΩ 1/16W J	
R154	NRSA63J-473X	MG RESISTOR	47kΩ 1/16W J		R775	NRSA63J-473X	MG RESISTOR	47kΩ 1/16W J	
R155	NRSA63J-473X	MG RESISTOR	47kΩ 1/16W J		R776	NRSA63J-102X	MG RESISTOR	1kΩ 1/16W J	
R156	NRSA63J-333X	MG RESISTOR	33kΩ 1/16W J		R777	NRSA63J-473X	MG RESISTOR	47kΩ 1/16W J	
R181	NRSA63J-273X	MG RESISTOR	27kΩ 1/16W J		R778	NRSA63J-102X	MG RESISTOR	1kΩ 1/16W J	
R182	NRSA63J-273X	MG RESISTOR	27kΩ 1/16W J		R779	NRSA63J-103X	MG RESISTOR	10kΩ 1/16W J	
R191	NRSA63J-222X	MG RESISTOR	2.2kΩ 1/16W J		R781	NRSA63J-104X	MG RESISTOR	100kΩ 1/16W J	
R192	NRSA63J-273X	MG RESISTOR	27kΩ 1/16W J		R782	NRSA63J-223X	MG RESISTOR	22kΩ 1/16W J	
R193	NRSA63J-0R0X	MG RESISTOR	0Ω 1/16W J		R783	NRSA63J-101X	MG RESISTOR	100Ω 1/16W J	
R195	NRSA63J-182X	MG RESISTOR	1.8kΩ 1/16W J		R784	NRSA63J-473X	MG RESISTOR	47kΩ 1/16W J	
R201	NRSA63J-123X	MG RESISTOR	12kΩ 1/16W J		R785	NRSA63J-101X	MG RESISTOR	100Ω 1/16W J	
R202	NRSA63J-273X	MG RESISTOR	27kΩ 1/16W J		R786	NRSA63J-473X	MG RESISTOR	47kΩ 1/16W J	
R241	NRSA63J-104X	MG RESISTOR	100kΩ 1/16W J		R787	NRSA63J-223X	MG RESISTOR	22kΩ 1/16W J	
R242	NRSA63J-101X	MG RESISTOR	100Ω 1/16W J		R788	NRSA63J-331X	MG RESISTOR	330Ω 1/16W J	
R251	NRSA63J-473X	MG RESISTOR	47kΩ 1/16W J		R789	NRSA63J-104X	MG RESISTOR	100kΩ 1/16W J	
R252	NRSA63J-472X	MG RESISTOR	4.7kΩ 1/16W J		R790	NRSA63J-103X	MG RESISTOR	10kΩ 1/16W J	
R254	NRSA63J-473X	MG RESISTOR	47kΩ 1/16W J		R901	QRE142J-102X	C RESISTOR	1kΩ 1/4W J	
R255	NRSA63J-473X	MG RESISTOR	47kΩ 1/16W J		R902	NRSA63J-912X	MG RESISTOR	9.1kΩ 1/16W J	
R256	NRSA63J-333X	MG RESISTOR	33kΩ 1/16W J		R903	NRSA63J-472X	MG RESISTOR	4.7kΩ 1/16W J	
R281	NRSA63J-273X	MG RESISTOR	27kΩ 1/16W J		R904	NRSA63J-562X	MG RESISTOR	5.6kΩ 1/16W J	
R282	NRSA63J-273X	MG RESISTOR	27kΩ 1/16W J		R905	NRSA63J-102X	MG RESISTOR	1kΩ 1/16W J	
R701	NRSA63J-102X	MG RESISTOR	1kΩ 1/16W J		R906	NRSA63J-103X	MG RESISTOR	10kΩ 1/16W J	
R703	NRSA63J-821X	MG RESISTOR	820Ω 1/16W J		R907	NRSA63J-473X	MG RESISTOR	47kΩ 1/16W J	
R704	NRSA63J-473X	MG RESISTOR	47kΩ 1/16W J		R908	NRSA63J-473X	MG RESISTOR	47kΩ 1/16W J	
R705	NRSA63J-106X	MG RESISTOR	10MΩ 1/16W J		R909	NRSA63J-473X	MG RESISTOR	47kΩ 1/16W J	
R706	NRSA63J-101X	MG RESISTOR	100Ω 1/16W J		R910	NRSA63J-153X	MG RESISTOR	15kΩ 1/16W J	
R707	NRSA63J-473X	MG RESISTOR	47kΩ 1/16W J		R911	NRSA63J-473X	MG RESISTOR	47kΩ 1/16W J	
R708	NRSA63J-222X	MG RESISTOR	2.2kΩ 1/16W J		R912	NRS181J-102X	MG RESISTOR	1kΩ 1/8W J	
R709	NRSA63J-102X	MG RESISTOR	1kΩ 1/16W J		R915	NRSA63J-473X	MG RESISTOR	47kΩ 1/16W J	
R710	NRSA63J-102X	MG RESISTOR	1kΩ 1/16W J		R916	NRSA63J-222X	MG RESISTOR	2.2kΩ 1/16W J	
R712	NRSA63J-102X	MG RESISTOR	1kΩ 1/16W J		R921	NRSA63J-473X	MG RESISTOR	47kΩ 1/16W J	
R713	NRSA63J-473X	MG RESISTOR	47kΩ 1/16W J		R922	NRSA63J-472X	MG RESISTOR	4.7kΩ 1/16W J	
R714	NRSA63J-102X	MG RESISTOR	1kΩ 1/16W J		R923	NRSA63J-104X	MG RESISTOR	100kΩ 1/16W J	
R715	NRSA63J-473X	MG RESISTOR	47kΩ 1/16W J		R971	NRSA63J-224X	MG RESISTOR	220kΩ 1/16W J	
					R972	NRSA63J-224X	MG RESISTOR	220kΩ 1/16W J	

△ Symbol No.	Part No.	Part Name	Description	Local	△ Symbol No.	Part No.	Part Name	Description	Local
R973	NRSA63J-473X	MG RESISTOR	47kΩ 1/16W J		D803	1SS355W-X	DIODE C.M		
R974	NRSA63J-184X	MG RESISTOR	180kΩ 1/16W J		D804	1SS355W-X	DIODE C.M		
R975	NRSA63J-223X	MG RESISTOR	22kΩ 1/16W J		D805	1SS355W-X	DIODE C.M		
R976	NRSA63J-123X	MG RESISTOR	12kΩ 1/16W J		D806	1SS355W-X	DIODE C.M		
R977	NRSA63J-470X	MG RESISTOR	47Ω 1/16W J		D807	1SS355W-X	DIODE C.M		
R978	NRSA63J-102X	MG RESISTOR	1kΩ 1/16W J		D808	1SS355W-X	DIODE C.M		
R979	NRSA63J-124X	MG RESISTOR	120kΩ 1/16W J		D809	1SS355W-X	DIODE C.M		
R980	NRSA63J-123X	MG RESISTOR	12kΩ 1/16W J		D811	NSPW310BS/BRST/	LED		
RA701	NRZ0065-102X	MG RESISTOR	1kΩ		D812	NSPW310BS/BRST/	LED		
RA702	NRZ0065-102X	MG RESISTOR	1kΩ		D813	NSPW310BS/BRST/	LED		
L1	QQL244J-4R7Z	COIL	4.7uH J		D814	TO1608BCHC/Z/-X	LED		
L701	QQL244J-470Z	COIL	47uH J		D815	LNJ308G81/1-3/X	LED		
L702	QQL244J-470Z	COIL	47uH J		D816	LNJ308G81/1-3/X	LED		
L703	QQL244J-470Z	COIL	47uH J		D817	LNJ308G81/1-3/X	LED		
L704	NQL114M-4R7X	COIL	4.7uH M		D818	LNJ308G81/1-3/X	LED		
L781	NQL093K-1R8X	COIL	1.8uH K		D819	LNJ308G81/1-3/X	LED		
L782	NQL093K-1R8X	COIL	1.8uH K		D820	LNJ308G81/1-3/X	LED		
L901	QQR0703-001	CHOKO COIL			D821	LNJ308G81/1-3/X	LED		
CN323	QGA2001F1-07	CONNECTOR	W-B (1-7)		D822	LNJ308G81/1-3/X	LED		
CN701	QGB1004K1-20	CONNECTOR	B-B (1-20)		D823	LNJ308G81/1-3/X	LED		
CN702	QGB1004K1-16	CONNECTOR	B-B (1-16)		D824	LNJ308G81/1-3/X	LED		
CN705	QGB2027M4-22S	CONNECTOR	B-B (1-22)		D825	LNJ308G81/1-3/X	LED		
CN901	QNZ0611-001	16P CONNECTOR			D826	LNJ308G81/1-3/X	LED		
CN902	QNZ0095-001	CONNECTOR			D827	LNJ308G81/1-3/X	LED		
J1	QNB0190-001	ANTENNA JACK			D828	LNJ308G81/1-3/X	LED		
TU1	QAU0403-001	TUNER PACK			D829	LNJ308G81/1-3/X	LED		
X701	QAX0617-001Z	CRYSTAL	12.500MHz		D830	LNJ308G81/1-3/X	LED		
X702	QAX0401-001	CRYSTAL	32.768KHz		D831	LNJ308G81/1-3/X	LED		
					D832	LNJ308G81/1-3/X	LED		
					D833	TO1608BCHC/Z/-X	LED		
					D834	TO1608BCHC/Z/-X	LED		
					D835	TO1608BCHC/Z/-X	LED		
					D836	TO1608BCHC/Z/-X	LED		
					D837	LNJ308G81/1-3/X	LED		
					D838	LNJ308G81/1-3/X	LED		
					D839	LNJ308G81/1-3/X	LED		
					D840	MC2838-X	DIODE		
					D841	UDZW5.1B-X	SI DIODE		

## Func board

Block No. [0][2]

△ Symbol No.	Part No.	Part Name	Description	Local
Q321	KTD1304-X	TRANSISTOR		
Q331	KTD1304-X	TRANSISTOR		
Q341	KTD1304-X	TRANSISTOR		
Q351	KTD1304-X	TRANSISTOR		
D321	MC2836-X	DIODE		
D331	MC2836-X	DIODE		
R321	NRSA63J-821X	MG RESISTOR	820Ω 1/16W J	
R322	NRSA63J-181X	MG RESISTOR	180Ω 1/16W J	
R325	NRSA63J-222X	MG RESISTOR	2.2kΩ 1/16W J	
R331	NRSA63J-821X	MG RESISTOR	820Ω 1/16W J	
R332	NRSA63J-181X	MG RESISTOR	180Ω 1/16W J	
R335	NRSA63J-222X	MG RESISTOR	2.2kΩ 1/16W J	
R341	NRSA63J-821X	MG RESISTOR	820Ω 1/16W J	
R342	NRSA63J-181X	MG RESISTOR	180Ω 1/16W J	
R345	NRSA63J-222X	MG RESISTOR	2.2kΩ 1/16W J	
R351	NRSA63J-821X	MG RESISTOR	820Ω 1/16W J	
R352	NRSA63J-181X	MG RESISTOR	180Ω 1/16W J	
R355	NRSA63J-222X	MG RESISTOR	2.2kΩ 1/16W J	
CN322	QGA2001F1-07	CONNECTOR	W-B (1-7)	
J321	QNN0740-001	PIN JACK		

## Switch board

Block No. [0][3]

△ Symbol No.	Part No.	Part Name	Description	Local
IC801	PT6578LQ-L	IC		
IC802	RPM7338-V4	RM.RECEIVER		
D801	UDZW5.1B-X	SI DIODE		
D802	UDZW9.1B-X	Z DIODE		

C801	NCB31CK-104X	C CAPACITOR	0.1uF 16V K
C802	NCB31CK-104X	C CAPACITOR	0.1uF 16V K
C803	NCB31CK-104X	C CAPACITOR	0.1uF 16V K
C804	NCB31CK-104X	C CAPACITOR	0.1uF 16V K
C805	NCS31HJ-681X	C CAPACITOR	680pF 50V J
C806	NBE20JM-475X	TA E CAPACITOR	4.7uF 6.3V M
C807	NBE21CM-475X	TA E CAPACITOR	4.7uF 16V M
C808	NBE20JM-475X	TA E CAPACITOR	4.7uF 6.3V M
C809	NBE20JM-475X	TA E CAPACITOR	4.7uF 6.3V M
C810	NCB31HK-472X	C CAPACITOR	4700pF 50V K
C811	NCB31HK-472X	C CAPACITOR	4700pF 50V K
C812	NCB31CK-473X	C CAPACITOR	0.047uF 16V K
C813	NCB31HK-103X	C CAPACITOR	0.01uF 50V K
C814	NCB31HK-103X	C CAPACITOR	0.01uF 50V K

R801	NRS181J-182X	MG RESISTOR	1.8kΩ 1/8W J
R802	NRSA63J-221X	MG RESISTOR	220Ω 1/16W J
R803	NRSA63J-821X	MG RESISTOR	820Ω 1/16W J
R804	NRSA63J-103X	MG RESISTOR	10kΩ 1/16W J
R805	NRSA63J-103X	MG RESISTOR	10kΩ 1/16W J
R806	NRSA63J-103X	MG RESISTOR	10kΩ 1/16W J
R807	NRSA63J-103X	MG RESISTOR	10kΩ 1/16W J
R808	NRSA63J-332X	MG RESISTOR	3.3kΩ 1/16W J
R809	NRSA63J-332X	MG RESISTOR	3.3kΩ 1/16W J
R810	NRSA63J-332X	MG RESISTOR	3.3kΩ 1/16W J
R811	NRSA63J-683X	MG RESISTOR	68kΩ 1/16W J
R812	NRSA63J-394X	MG RESISTOR	390kΩ 1/16W J
R814	NRS181J-391X	MG RESISTOR	390Ω 1/8W J
R816	NRS181J-391X	MG RESISTOR	390Ω 1/8W J
R818	NRS181J-391X	MG RESISTOR	390Ω 1/8W J
R820	NRSA02J-471X	MG RESISTOR	470Ω 1/10W J
R822	NRSA02J-681X	MG RESISTOR	680Ω 1/10W J
R824	NRSA02J-471X	MG RESISTOR	470Ω 1/10W J
R826	NRSA02J-471X	MG RESISTOR	470Ω 1/10W J
R828	NRSA02J-331X	MG RESISTOR	330Ω 1/10W J
R830	NRSA02J-331X	MG RESISTOR	330Ω 1/10W J
R832	NRSA02J-331X	MG RESISTOR	330Ω 1/10W J
R834	NRSA02J-331X	MG RESISTOR	330Ω 1/10W J
R836	NRSA02J-331X	MG RESISTOR	330Ω 1/10W J

△ Symbol No.	Part No.	Part Name	Description	Local	△ Symbol No.	Part No.	Part Name	Description	Local
R838	NRSA02J-331X	MG RESISTOR	330Ω 1/10W J		IC601	TA2157FN-X	RF AMP IC		
R840	NRSA02J-331X	MG RESISTOR	330Ω 1/10W J		IC621	TC94A14FA	IC		
R842	NRSA02J-471X	MG RESISTOR	470Ω 1/10W J		IC651	NJU7772F15-X	IC		
R844	NRSA02J-471X	MG RESISTOR	470Ω 1/10W J		IC652	TC94A34FG-002	IC		
R846	NRSA02J-331X	MG RESISTOR	330Ω 1/10W J		IC681	BA5830FP-X	IC		
R848	NRSA02J-331X	MG RESISTOR	330Ω 1/10W J						
R850	NRSA02J-471X	MG RESISTOR	470Ω 1/10W J		Q501	RT1P141C-X	DIGI TRANSISTOR		
R852	NRSA02J-222X	MG RESISTOR	2.2kΩ 1/10W J		Q502	RT1N141C-X	DIGI TRANSISTOR		
R853	NRSA63J-103X	MG RESISTOR	10kΩ 1/16W J		Q571	RT1P141C-X	DIGI TRANSISTOR		
R854	NRSA63J-471X	MG RESISTOR	470Ω 1/16W J		Q572	RT1N141C-X	DIGI TRANSISTOR		
R855	NRSA63J-103X	MG RESISTOR	10kΩ 1/16W J		Q573	2SA1365/F/-X	TRANSISTOR		
R856	NRSA63J-473X	MG RESISTOR	47kΩ 1/16W J		Q574	RT1N141C-X	DIGI TRANSISTOR		
R857	NRSA63J-473X	MG RESISTOR	47kΩ 1/16W J		Q601	2SA1947/E/-X	CHIP.TR.C.M		
R859	NRSA63J-0R0X	MG RESISTOR	0Ω 1/16W J		Q651	2SA1365/F/-X	TRANSISTOR		
R860	NRSA63J-0R0X	MG RESISTOR	0Ω 1/16W J		Q652	RT1N141C-X	DIGI TRANSISTOR		
R863	NRSA63J-332X	MG RESISTOR	3.3kΩ 1/16W J		Q681	2SB1184/QR/-X	TRANSISTOR		
R871	NRSA63J-621X	MG RESISTOR	620Ω 1/16W J						
R872	NRSA63J-621X	MG RESISTOR	620Ω 1/16W J		D506	1SS355W-X	DIODE C.M		
R873	NRSA63J-821X	MG RESISTOR	820Ω 1/16W J		D682	1SR154-400-X	DIODE		
R874	NRSA63J-122X	MG RESISTOR	1.2kΩ 1/16W J						
R875	NRSA63J-621X	MG RESISTOR	620Ω 1/16W J		C501	NCB31HK-103X	C CAPACITOR	0.01uF 50V K	
R876	NRSA63J-621X	MG RESISTOR	620Ω 1/16W J		C502	NCB31HK-103X	C CAPACITOR	0.01uF 50V K	
R877	NRSA63J-821X	MG RESISTOR	820Ω 1/16W J		C503	NEAG0JM-107X	E CAPACITOR	100uF 6.3V M	
R878	NRSA63J-122X	MG RESISTOR	1.2kΩ 1/16W J		C504	NDC31HJ-220X	C CAPACITOR	22pF 50V J	
R879	NRSA63J-182X	MG RESISTOR	1.8kΩ 1/16W J		C505	NDC31HJ-220X	C CAPACITOR	22pF 50V J	
R880	NRSA63J-302X	MG RESISTOR	3kΩ 1/16W J		C506	NCB31HK-103X	C CAPACITOR	0.01uF 50V K	
R881	NRSA63J-562X	MG RESISTOR	5.6kΩ 1/16W J		C507	NCB31HK-103X	C CAPACITOR	0.01uF 50V K	
R882	NRSA63J-621X	MG RESISTOR	620Ω 1/16W J		C508	NCB31HK-103X	C CAPACITOR	0.01uF 50V K	
R883	NRSA63J-621X	MG RESISTOR	620Ω 1/16W J		C509	NCB31HK-103X	C CAPACITOR	0.01uF 50V K	
R884	NRSA63J-821X	MG RESISTOR	820Ω 1/16W J		C510	NCB31HK-103X	C CAPACITOR	0.01uF 50V K	
R885	NRSA63J-122X	MG RESISTOR	1.2kΩ 1/16W J		C511	NCB31CK-104X	C CAPACITOR	0.1uF 16V K	
R886	NRSA63J-182X	MG RESISTOR	1.8kΩ 1/16W J		C512	NEAG0JM-107X	E CAPACITOR	100uF 6.3V M	
R887	NRSA63J-302X	MG RESISTOR	3kΩ 1/16W J		C513	NCB31HK-103X	C CAPACITOR	0.01uF 50V K	
					C514	NCS31HJ-102X	C CAPACITOR	1000pF 50V J	
CN801	QGB1004J2-20X	CONNECTOR	B-B (1-20)		C551	NCB31HK-103X	C CAPACITOR	0.01uF 50V K	
CN802	QGB1004J2-16X	CONNECTOR	B-B (1-16)		C561	NCB31HK-123X	C CAPACITOR	0.012uF 50V K	
CN803	QGB1004J2-16X	CONNECTOR	B-B (1-16)		C571	NDC31HJ-270X	C CAPACITOR	27pF 50V J	
EN851	QSW0976-001	ROTARY ENCODER			C572	NDC31HJ-270X	C CAPACITOR	27pF 50V J	
PJ801	QNS0180-002	3.5 JACK			C573	NCB31CK-104X	C CAPACITOR	0.1uF 16V K	
S851	NSW0206-001X	TACT SWITCH			C574	NEAG0JM-107X	E CAPACITOR	100uF 6.3V M	
S852	NSW0206-001X	TACT SWITCH			C575	NEAG0JM-107X	E CAPACITOR	100uF 6.3V M	
S853	NSW0206-001X	TACT SWITCH			C577	NCB31CK-104X	C CAPACITOR	0.1uF 16V K	
S854	NSW0206-001X	TACT SWITCH			C578	NEAG0JM-107X	E CAPACITOR	100uF 6.3V M	
S855	NSW0206-001X	TACT SWITCH			C580	NCB31HK-123X	C CAPACITOR	0.012uF 50V K	
S856	NSW0206-001X	TACT SWITCH			C581	NDC31HJ-101X	C CAPACITOR	100pF 50V J	
S857	NSW0206-001X	TACT SWITCH			C582	NDC31HJ-101X	C CAPACITOR	100pF 50V J	
S858	NSW0206-001X	TACT SWITCH			C583	NCS31HJ-821X	C CAPACITOR	820pF 50V J	
S859	NSW0206-001X	TACT SWITCH			C584	NCS31HJ-821X	C CAPACITOR	820pF 50V J	
S860	NSW0206-001X	TACT SWITCH			C585	NEAG1VM-475X	E CAPACITOR	4.7uF 35V M	
S861	NSW0206-001X	TACT SWITCH			C586	NEAG1VM-475X	E CAPACITOR	4.7uF 35V M	
S862	NSW0206-001X	TACT SWITCH			C587	NDC31HJ-151X	C CAPACITOR	150pF 50V J	
S863	NSW0206-001X	TACT SWITCH			C588	NDC31HJ-151X	C CAPACITOR	150pF 50V J	
S864	NSW0206-001X	TACT SWITCH			C589	NEAG1VM-475X	E CAPACITOR	4.7uF 35V M	
S865	NSW0206-001X	TACT SWITCH			C590	NEAG1VM-475X	E CAPACITOR	4.7uF 35V M	
S866	NSW0206-001X	TACT SWITCH			C591	NEAG0JM-476X	E CAPACITOR	47uF 6.3V M	
S867	NSW0206-001X	TACT SWITCH			C592	NEAG0JM-476X	E CAPACITOR	47uF 6.3V M	
S868	NSW0206-001X	TACT SWITCH			C593	NEAG1CM-476X	E CAPACITOR	47uF 16V M	
S869	NSW0206-001X	TACT SWITCH			C594	NCS31HJ-102X	C CAPACITOR	1000pF 50V J	
S870	NSW0206-001X	TACT SWITCH			C595	NCB31CK-473X	C CAPACITOR	0.047uF 16V K	
S871	NSW0206-001X	TACT SWITCH			C596	NDC31HJ-101X	C CAPACITOR	100pF 50V J	
TH855	NAD0028-103X	N THERMISTOR	10kΩ		C597	NCS31HJ-102X	C CAPACITOR	1000pF 50V J	
					C598	NCS31HJ-102X	C CAPACITOR	1000pF 50V J	
					C601	NEAG0JM-476X	E CAPACITOR	47uF 6.3V M	
					C602	NCB31HK-103X	C CAPACITOR	0.01uF 50V K	
					C603	NEAG0JM-107X	E CAPACITOR	100uF 6.3V M	
					C604	NCB31HK-103X	C CAPACITOR	0.01uF 50V K	
					C605	NCB31HK-682X	C CAPACITOR	6800pF 50V K	
					C606	NEAG0JM-476X	E CAPACITOR	47uF 6.3V M	
					C607	NCB31HK-103X	C CAPACITOR	0.01uF 50V K	
					C608	NCB31CK-104X	C CAPACITOR	0.1uF 16V K	
					C609	NCB31CK-104X	C CAPACITOR	0.1uF 16V K	
					C610	NDC31HJ-5R0X	C CAPACITOR	5pF 50V J	
					C611	NDC31HJ-680X	C CAPACITOR	68pF 50V J	
					C612	NCB31HK-103X	C CAPACITOR	0.01uF 50V K	
					C613	NCB31HK-103X	C CAPACITOR	0.01uF 50V K	
					C614	NCB31HK-103X	C CAPACITOR	0.01uF 50V K	
					C616	NBE20JM-106X	TA E CAPACITOR	10uF 6.3V M	
					C621	NCB31HK-103X	C CAPACITOR	0.01uF 50V K	

## CD mechanism control board

Block No. [0][4]

△ Symbol No.	Part No.	Part Name	Description	Local
IC501	TMP91CW12AF5VD9	IC		
IC502	BR24L01AFV-W-X	IC		
IC503	SN74AHCT126PW-X	IC(DIGITAL)		
IC504	NJU7241F33-X	IC		
IC571	PCM1753-X	IC		
IC572	NJM4580V-X	IC		
IC573	SN74AHCU04PW-X	IC		



△ Symbol No.	Part No.	Part Name	Description	Local	△ Symbol No.	Part No.	Part Name	Description	Local
C622	NEAG0JM-476X	E CAPACITOR	47uF 6.3V M		R533	NRSA63J-101X	MG RESISTOR	100Ω 1/16W J	
C623	NDC31HJ-470X	C CAPACITOR	47pF 50V J		R534	NRSA63J-101X	MG RESISTOR	100Ω 1/16W J	
C624	NCB31HK-153X	C CAPACITOR	0.015uF 50V K		R535	NRSA63J-101X	MG RESISTOR	100Ω 1/16W J	
C625	NCB31HK-103X	C CAPACITOR	0.01uF 50V K		R536	NRSA63J-101X	MG RESISTOR	100Ω 1/16W J	
C626	NCB31HK-272X	C CAPACITOR	2700pF 50V K		R537	NRSA63J-101X	MG RESISTOR	100Ω 1/16W J	
C627	NCB31HK-103X	C CAPACITOR	0.01uF 50V K		R539	NRSA63J-473X	MG RESISTOR	47kΩ 1/16W J	
C628	NEAG0JM-476X	E CAPACITOR	47uF 6.3V M		R540	NRSA63J-473X	MG RESISTOR	47kΩ 1/16W J	
C629	NCB31EK-333X	C CAPACITOR	0.033uF 25V K		R541	NRSA63J-101X	MG RESISTOR	100Ω 1/16W J	
C630	NCB31EK-333X	C CAPACITOR	0.033uF 25V K		R542	NRSA63J-103X	MG RESISTOR	10kΩ 1/16W J	
C631	NDC31HJ-471X	C CAPACITOR	470pF 50V J		R543	NRSA63J-101X	MG RESISTOR	100Ω 1/16W J	
C632	NDC31HJ-471X	C CAPACITOR	470pF 50V J		R544	NRSA63J-101X	MG RESISTOR	100Ω 1/16W J	
C633	NCB31CK-473X	C CAPACITOR	0.047uF 16V K		R545	NRSA63J-103X	MG RESISTOR	10kΩ 1/16W J	
C634	NCB31CK-473X	C CAPACITOR	0.047uF 16V K		R546	NRSA63J-271X	MG RESISTOR	270Ω 1/16W J	
C635	NCB31CK-473X	C CAPACITOR	0.047uF 16V K		R547	NRSA63J-271X	MG RESISTOR	270Ω 1/16W J	
C636	NCB31CK-473X	C CAPACITOR	0.047uF 16V K		R548	NRSA63J-822X	MG RESISTOR	8.2kΩ 1/16W J	
C637	NCB31CK-473X	C CAPACITOR	0.047uF 16V K		R549	NRSA63J-472X	MG RESISTOR	4.7kΩ 1/16W J	
C638	NCB31HK-103X	C CAPACITOR	0.01uF 50V K		R550	NRSA63J-472X	MG RESISTOR	4.7kΩ 1/16W J	
C639	NEAG0JM-476X	E CAPACITOR	47uF 6.3V M		R551	NRSA63J-104X	MG RESISTOR	100kΩ 1/16W J	
C640	NCB31HK-103X	C CAPACITOR	0.01uF 50V K		R552	NRSA63J-104X	MG RESISTOR	100kΩ 1/16W J	
C641	NEAG0JM-476X	E CAPACITOR	47uF 6.3V M		R553	NRSA63J-183X	MG RESISTOR	18kΩ 1/16W J	
C642	NDC31HJ-101X	C CAPACITOR	100pF 50V J		R554	NRSA63J-333X	MG RESISTOR	33kΩ 1/16W J	
C643	NCB31HK-103X	C CAPACITOR	0.01uF 50V K		R555	NRSA63J-101X	MG RESISTOR	100Ω 1/16W J	
C644	NCB31AK-334X	C CAPACITOR	0.33uF 10V K		R556	NRSA63J-0R0X	MG RESISTOR	0Ω 1/16W J	
C645	NEAG0JM-476X	E CAPACITOR	47uF 6.3V M		R557	NRSA63J-104X	MG RESISTOR	100kΩ 1/16W J	
C646	NCB31HK-103X	C CAPACITOR	0.01uF 50V K		R558	NRSA63J-104X	MG RESISTOR	100kΩ 1/16W J	
C651	NEAG0JM-476X	E CAPACITOR	47uF 6.3V M		R559	NRSA63J-0R0X	MG RESISTOR	0Ω 1/16W J	
C652	NCB31HK-103X	C CAPACITOR	0.01uF 50V K		R560	NRSA63J-101X	MG RESISTOR	100Ω 1/16W J	
C653	NEAG0JM-476X	E CAPACITOR	47uF 6.3V M		R561	NRSA63J-104X	MG RESISTOR	100kΩ 1/16W J	
C654	NCB31CK-104X	C CAPACITOR	0.1uF 16V K		R562	NRSA63J-392X	MG RESISTOR	3.9kΩ 1/16W J	
C655	NCB31HK-103X	C CAPACITOR	0.01uF 50V K		R563	NRSA63J-682X	MG RESISTOR	6.8kΩ 1/16W J	
C656	NCB31CK-104X	C CAPACITOR	0.1uF 16V K		R568	NRSA63J-102X	MG RESISTOR	1kΩ 1/16W J	
C659	NCB31CK-104X	C CAPACITOR	0.1uF 16V K		R569	NRSA63J-102X	MG RESISTOR	1kΩ 1/16W J	
C660	NDC31HJ-101X	C CAPACITOR	100pF 50V J		R570	NRSA63J-102X	MG RESISTOR	1kΩ 1/16W J	
C661	NCB31HK-103X	C CAPACITOR	0.01uF 50V K		R572	NRSA63J-225X	MG RESISTOR	2.2MΩ 1/16W J	
C662	NDC31HJ-101X	C CAPACITOR	100pF 50V J		R573	NRSA63J-102X	MG RESISTOR	1kΩ 1/16W J	
C663	NBE20JM-106X	TA E CAPACITOR	10uF 6.3V M		R574	NRSA63J-470X	MG RESISTOR	47Ω 1/16W J	
C664	NCB31HK-222X	C CAPACITOR	2200pF 50V K		R575	NRSA63J-102X	MG RESISTOR	1kΩ 1/16W J	
C665	NCB31CK-104X	C CAPACITOR	0.1uF 16V K		R576	NRSA63J-102X	MG RESISTOR	1kΩ 1/16W J	
C666	NDC31HJ-101X	C CAPACITOR	100pF 50V J		R577	NRSA63J-101X	MG RESISTOR	100Ω 1/16W J	
C667	NCB31HK-103X	C CAPACITOR	0.01uF 50V K		R578	NRSA63J-473X	MG RESISTOR	47kΩ 1/16W J	
C668	NEAG0JM-476X	E CAPACITOR	47uF 6.3V M		R579	NRSA63J-222X	MG RESISTOR	2.2kΩ 1/16W J	
C669	NCB31HK-103X	C CAPACITOR	0.01uF 50V K		R581	NRSA63J-243X	MG RESISTOR	24kΩ 1/16W J	
C682	NEAG1VM-475X	E CAPACITOR	4.7uF 35V M		R582	NRSA63J-243X	MG RESISTOR	24kΩ 1/16W J	
C683	NCB31CK-104X	C CAPACITOR	0.1uF 16V K		R583	NRSA63J-822X	MG RESISTOR	8.2kΩ 1/16W J	
C684	NEAG1CM-476X	E CAPACITOR	47uF 16V M		R584	NRSA63J-822X	MG RESISTOR	8.2kΩ 1/16W J	
C689	NEAG1CM-476X	E CAPACITOR	47uF 16V M		R585	NRSA63J-273X	MG RESISTOR	27kΩ 1/16W J	
C690	NBE20JM-106X	TA E CAPACITOR	10uF 6.3V M		R586	NRSA63J-273X	MG RESISTOR	27kΩ 1/16W J	
C693	NEAG1CM-476X	E CAPACITOR	47uF 16V M		R587	NRSA63J-473X	MG RESISTOR	47kΩ 1/16W J	
					R588	NRSA63J-473X	MG RESISTOR	47kΩ 1/16W J	
R501	NRSA63J-102X	MG RESISTOR	1kΩ 1/16W J		R589	NRSA63J-103X	MG RESISTOR	10kΩ 1/16W J	
R502	NRSA63J-102X	MG RESISTOR	1kΩ 1/16W J		R590	NRSA63J-103X	MG RESISTOR	10kΩ 1/16W J	
R503	NRSA63J-102X	MG RESISTOR	1kΩ 1/16W J		R591	NRSA63J-103X	MG RESISTOR	10kΩ 1/16W J	
R504	NRSA63J-101X	MG RESISTOR	100Ω 1/16W J		R592	NRSA63J-103X	MG RESISTOR	10kΩ 1/16W J	
R505	NRSA63J-101X	MG RESISTOR	100Ω 1/16W J		R593	NRSA63J-4R7X	MG RESISTOR	4.7Ω 1/16W J	
R506	NRSA63J-473X	MG RESISTOR	47kΩ 1/16W J		R594	NRSA63J-470X	MG RESISTOR	47Ω 1/16W J	
R507	NRSA63J-473X	MG RESISTOR	47kΩ 1/16W J		R595	NRSA63J-470X	MG RESISTOR	47Ω 1/16W J	
R508	NRSA63J-473X	MG RESISTOR	47kΩ 1/16W J		R601	NRSA63J-823X	MG RESISTOR	82kΩ 1/16W J	
R509	NRSA63J-473X	MG RESISTOR	47kΩ 1/16W J		R602	NRSA63J-823X	MG RESISTOR	82kΩ 1/16W J	
R510	NRSA63J-101X	MG RESISTOR	100Ω 1/16W J		R603	NRSA63J-334X	MG RESISTOR	330kΩ 1/16W J	
R511	NRSA63J-102X	MG RESISTOR	1kΩ 1/16W J		R604	NRSA63J-334X	MG RESISTOR	330kΩ 1/16W J	
R512	NRSA63J-473X	MG RESISTOR	47kΩ 1/16W J		R605	NRSA63J-220X	MG RESISTOR	22Ω 1/16W J	
R513	NRSA63J-102X	MG RESISTOR	1kΩ 1/16W J		R606	NRSA63J-220X	MG RESISTOR	22Ω 1/16W J	
R514	NRSA63J-473X	MG RESISTOR	47kΩ 1/16W J		R607	NRSA63J-823X	MG RESISTOR	82kΩ 1/16W J	
R515	NRSA63J-473X	MG RESISTOR	47kΩ 1/16W J		R608	NRSA63J-821X	MG RESISTOR	820Ω 1/16W J	
R516	NRSA63J-102X	MG RESISTOR	1kΩ 1/16W J		R609	NRSA63J-563X	MG RESISTOR	56kΩ 1/16W J	
R517	NRSA63J-101X	MG RESISTOR	100Ω 1/16W J		R610	NRSA63J-101X	MG RESISTOR	100Ω 1/16W J	
R518	NRSA63J-101X	MG RESISTOR	100Ω 1/16W J		R611	NRSA63J-103X	MG RESISTOR	10kΩ 1/16W J	
R519	NRSA63J-101X	MG RESISTOR	100Ω 1/16W J		R612	NRSA63J-202X	MG RESISTOR	2kΩ 1/16W J	
R520	NRSA63J-101X	MG RESISTOR	100Ω 1/16W J		R613	NRSA63J-102X	MG RESISTOR	1kΩ 1/16W J	
R521	NRSA63J-101X	MG RESISTOR	100Ω 1/16W J		R614	NRSA63J-153X	MG RESISTOR	15kΩ 1/16W J	
R522	NRSA63J-101X	MG RESISTOR	100Ω 1/16W J		R615	NRSA63J-151X	MG RESISTOR	150Ω 1/16W J	
R523	NRSA63J-101X	MG RESISTOR	100Ω 1/16W J		R616	NRSA63J-103X	MG RESISTOR	10kΩ 1/16W J	
R525	NRSA63J-104X	MG RESISTOR	100kΩ 1/16W J		R621	NRSA63J-470X	MG RESISTOR	47Ω 1/16W J	
R526	NRSA63J-473X	MG RESISTOR	47kΩ 1/16W J		R622	NRSA63J-470X	MG RESISTOR	47Ω 1/16W J	
R528	NRSA63J-473X	MG RESISTOR	47kΩ 1/16W J		R623	NRSA63J-470X	MG RESISTOR	47Ω 1/16W J	
R530	NRSA63J-473X	MG RESISTOR	47kΩ 1/16W J		R624	NRSA63J-562X	MG RESISTOR	5.6kΩ 1/16W J	
R531	NRSA63J-473X	MG RESISTOR	47kΩ 1/16W J		R625	NRSA63J-473X	MG RESISTOR	47kΩ 1/16W J	
R532	NRSA63J-102X	MG RESISTOR	1kΩ 1/16W J		R626	NRSA63J-474X	MG RESISTOR	470kΩ 1/16W J	

△ Symbol No.	Part No.	Part Name	Description	Local	△ Symbol No.	Part No.	Part Name	Description	Local
R627	NRSA63J-153X	MG RESISTOR	15kΩ 1/16W J		C405	NDC31HJ-101X	C CAPACITOR	100pF 50V J	
R628	NRSA63J-155X	MG RESISTOR	1.5MΩ 1/16W J		C406	NDC31HJ-101X	C CAPACITOR	100pF 50V J	
R629	NRSA63J-103X	MG RESISTOR	10kΩ 1/16W J		C407	NDC31HJ-101X	C CAPACITOR	100pF 50V J	
R630	NRSA63J-101X	MG RESISTOR	100Ω 1/16W J		C408	NDC31HJ-101X	C CAPACITOR	100pF 50V J	
R631	NRSA63J-101X	MG RESISTOR	100Ω 1/16W J		C409	QEKJ1CM-226Z	E CAPACITOR	22uF 16V M	
R632	NRSA63J-0R0X	MG RESISTOR	0Ω 1/16W J		C410	NCB31HK-153X	C CAPACITOR	0.015uF 50V K	
R633	NRSA63J-0R0X	MG RESISTOR	0Ω 1/16W J		C411	NCB31HK-153X	C CAPACITOR	0.015uF 50V K	
R634	NRSA63J-0R0X	MG RESISTOR	0Ω 1/16W J		C412	NCB31CK-104X	C CAPACITOR	0.1uF 16V K	
R635	NRSA63J-101X	MG RESISTOR	100Ω 1/16W J		C413	NCB31CK-104X	C CAPACITOR	0.1uF 16V K	
R636	NRSA63J-101X	MG RESISTOR	100Ω 1/16W J		C414	QEKJ1CM-226Z	E CAPACITOR	22uF 16V M	
R637	NRSA63J-105X	MG RESISTOR	1MΩ 1/16W J		C416	NCB31CK-104X	C CAPACITOR	0.1uF 16V K	
R638	NRSA63J-472X	MG RESISTOR	4.7kΩ 1/16W J		C417	NCB31CK-104X	C CAPACITOR	0.1uF 16V K	
R639	NRSA63J-472X	MG RESISTOR	4.7kΩ 1/16W J		C418	NDC31HJ-221X	C CAPACITOR	220pF 50V J	
R640	NRSA63J-472X	MG RESISTOR	4.7kΩ 1/16W J		C419	QEKJ1HM-474Z	E CAPACITOR	0.47uF 50V M	
R641	NRSA63J-472X	MG RESISTOR	4.7kΩ 1/16W J		C421	NCB31HK-103X	C CAPACITOR	0.01uF 50V K	
R642	NRSA63J-103X	MG RESISTOR	10kΩ 1/16W J		C422	NCB31CK-104X	C CAPACITOR	0.1uF 16V K	
R651	NRSA63J-104X	MG RESISTOR	100kΩ 1/16W J		C423	QEKJ1CM-106Z	E CAPACITOR	10uF 16V M	
R654	NRSA63J-390X	MG RESISTOR	39Ω 1/16W J		C424	NCB31CK-104X	C CAPACITOR	0.1uF 16V K	
R655	NRSA63J-103X	MG RESISTOR	10kΩ 1/16W J		C425	NCB31HK-103X	C CAPACITOR	0.01uF 50V K	
R656	NRSA63J-473X	MG RESISTOR	47kΩ 1/16W J		C426	QEKJ1CM-106Z	E CAPACITOR	10uF 16V M	
R657	NRSA63J-222X	MG RESISTOR	2.2kΩ 1/16W J		C427	QEKJ1CM-106Z	E CAPACITOR	10uF 16V M	
R668	NRSA63J-470X	MG RESISTOR	47Ω 1/16W J		C428	NDC31HJ-101X	C CAPACITOR	100pF 50V J	
R675	NRSA63J-221X	MG RESISTOR	220Ω 1/16W J		C431	QEKJ0JM-476Z	E CAPACITOR	47uF 6.3V M	
R681	NRSA63J-682X	MG RESISTOR	6.8kΩ 1/16W J		C432	NCB31HK-103X	C CAPACITOR	0.01uF 50V K	
R682	NRSA63J-222X	MG RESISTOR	2.2kΩ 1/16W J		C433	QEKJ0JM-476Z	E CAPACITOR	47uF 6.3V M	
R683	NRSA63J-682X	MG RESISTOR	6.8kΩ 1/16W J		C434	NCB31HK-103X	C CAPACITOR	0.01uF 50V K	
R684	NRSA63J-822X	MG RESISTOR	8.2kΩ 1/16W J		C435	NDC31HJ-220X	C CAPACITOR	22pF 50V J	
R685	NRSA63J-682X	MG RESISTOR	6.8kΩ 1/16W J		C436	NDC31HJ-220X	C CAPACITOR	22pF 50V J	
R686	NRSA63J-123X	MG RESISTOR	12kΩ 1/16W J		C437	NCB31HK-103X	C CAPACITOR	0.01uF 50V K	
R687	NRSA63J-682X	MG RESISTOR	6.8kΩ 1/16W J		C438	NCB31HK-103X	C CAPACITOR	0.01uF 50V K	
R688	NRSA63J-182X	MG RESISTOR	1.8kΩ 1/16W J		C439	NCB31HK-103X	C CAPACITOR	0.01uF 50V K	
R689	NRSA63J-123X	MG RESISTOR	12kΩ 1/16W J		C461	NCB31HK-103X	C CAPACITOR	0.01uF 50V K	
R690	NRSA63J-333X	MG RESISTOR	33kΩ 1/16W J		R401	NRS181J-681X	MG RESISTOR	680Ω 1/8W J	
R691	NRSA63J-153X	MG RESISTOR	15kΩ 1/16W J		R402	NRSA63J-104X	MG RESISTOR	100kΩ 1/16W J	
L501	NQL114K-470X	COIL	47uH K		R403	NRSA63J-104X	MG RESISTOR	100kΩ 1/16W J	
L502	NQL114K-470X	COIL	47uH K		R404	NRSA63J-104X	MG RESISTOR	100kΩ 1/16W J	
L572	NQL114K-470X	COIL	47uH K		R405	NRSA63J-104X	MG RESISTOR	100kΩ 1/16W J	
L621	NQL114K-470X	COIL	47uH K		R406	NRSA63J-181X	MG RESISTOR	180Ω 1/16W J	
L622	NQL114K-470X	COIL	47uH K		R407	NRSA63J-181X	MG RESISTOR	180Ω 1/16W J	
L623	NQL114K-470X	COIL	47uH K		R412	NRSA63J-101X	MG RESISTOR	100Ω 1/16W J	
L651	NQL114K-470X	COIL	47uH K		R413	NRSA63J-183X	MG RESISTOR	18kΩ 1/16W J	
L652	NQL114K-470X	COIL	47uH K		R414	NRSA63J-392X	MG RESISTOR	3.9kΩ 1/16W J	
L653	NQL114K-470X	COIL	47uH K		R415	NRSA63J-223X	MG RESISTOR	22kΩ 1/16W J	
CN501	QGB2027L1-22X	CONNECTOR	B-B (1-22)		R416	NRSA63J-155X	MG RESISTOR	1.5MΩ 1/16W J	
CN601	QGF0501F8-22X	CONNECTOR	FFC/FPC (1-22)		R417	NRSA63J-103X	MG RESISTOR	10kΩ 1/16W J	
TH501	NAD0028-103X	N THERMISTOR	10kΩ		R418	NRSA63J-153X	MG RESISTOR	15kΩ 1/16W J	
X501	NAX0385-001X	CRYSTAL	24.576MHz		R422	NRSA63J-332X	MG RESISTOR	3.3kΩ 1/16W J	
X571	NAX0375-001X	CRYSTAL	16.9344MHz		R423	NRSA63J-473X	MG RESISTOR	47kΩ 1/16W J	
					R424	NRSA63J-222X	MG RESISTOR	2.2kΩ 1/16W J	
					R425	NRSA63J-680X	MG RESISTOR	68Ω 1/16W J	
					R426	NRSA63J-680X	MG RESISTOR	68Ω 1/16W J	
					R432	NRSA63J-473X	MG RESISTOR	47kΩ 1/16W J	
					R433	NRSA63J-473X	MG RESISTOR	47kΩ 1/16W J	
					R435	NRSA63J-473X	MG RESISTOR	47kΩ 1/16W J	
					R437	NRSA63J-473X	MG RESISTOR	47kΩ 1/16W J	
					R438	NRSA63J-473X	MG RESISTOR	47kΩ 1/16W J	
					R439	NRSA63J-473X	MG RESISTOR	47kΩ 1/16W J	
					R440	NRSA63J-473X	MG RESISTOR	47kΩ 1/16W J	
					R441	NRSA63J-473X	MG RESISTOR	47kΩ 1/16W J	
					R442	NRSA63J-473X	MG RESISTOR	47kΩ 1/16W J	
					R443	NRSA63J-222X	MG RESISTOR	2.2kΩ 1/16W J	
					R444	NRSA63J-473X	MG RESISTOR	47kΩ 1/16W J	
					R445	NRSA63J-563X	MG RESISTOR	56kΩ 1/16W J	
					R446	NRSA63J-473X	MG RESISTOR	47kΩ 1/16W J	
					R447	NRSA63J-473X	MG RESISTOR	47kΩ 1/16W J	
					R448	NRSA63J-683X	MG RESISTOR	68kΩ 1/16W J	
					R449	NRSA63J-103X	MG RESISTOR	10kΩ 1/16W J	
					R450	NRSA63J-473X	MG RESISTOR	47kΩ 1/16W J	
					R451	NRSA63J-473X	MG RESISTOR	47kΩ 1/16W J	
					R454	NRSA63J-473X	MG RESISTOR	47kΩ 1/16W J	
					R455	NRSA63J-102X	MG RESISTOR	1kΩ 1/16W J	
					R456	NRSA63J-102X	MG RESISTOR	1kΩ 1/16W J	
					R457	NRSA63J-102X	MG RESISTOR	1kΩ 1/16W J	
					R458	NRSA63J-102X	MG RESISTOR	1kΩ 1/16W J	
					R461	NRSA63J-223X	MG RESISTOR	22kΩ 1/16W J	
					R462	NRSA63J-334X	MG RESISTOR	330kΩ 1/16W J	
					R463	NRSA63J-101X	MG RESISTOR	100Ω 1/16W J	

## Cassette mechanism control board

Block No. [0][5]

△ Symbol No.	Part No.	Part Name	Description	Local
IC401	CXA2560Q	IC		
IC402	LB1641	IC		
IC431	UPD789166GB-590	IC		
IC432	BD4833FVE-W	IC		
IC461	SN74AHC126NS-X	IC		
Q402	RT1N141C-X	DIGI TRANSISTOR		
Q403	2SB1322/RS/-T	TRANSISTOR		
Q431	RT1N141C-X	DIGI TRANSISTOR		
Q432	2SC3928A/QR/-X	TRANSISTOR		
D401	MA8047/H/-X	Z DIODE		
D402	1A3G-T1	SI DIODE		
C401	NDC31HJ-101X	C CAPACITOR	100pF 50V J	
C402	NDC31HJ-101X	C CAPACITOR	100pF 50V J	
C403	NDC31HJ-101X	C CAPACITOR	100pF 50V J	
C404	NDC31HJ-101X	C CAPACITOR	100pF 50V J	

△ Symbol No.	Part No.	Part Name	Description	Local
R464	NRSA63J-104X	MG RESISTOR	100kΩ 1/16W J	
R465	NRSA63J-223X	MG RESISTOR	22kΩ 1/16W J	
R466	NRSA63J-104X	MG RESISTOR	100kΩ 1/16W J	
R467	NRSA63J-103X	MG RESISTOR	10kΩ 1/16W J	
R468	NRSA63J-331X	MG RESISTOR	330Ω 1/16W J	
R469	NRSA63J-223X	MG RESISTOR	22kΩ 1/16W J	
R470	NRSA63J-101X	MG RESISTOR	100Ω 1/16W J	
R471	NRSA63J-334X	MG RESISTOR	330kΩ 1/16W J	
R491	NRSA63J-0R0X	MG RESISTOR	0Ω 1/16W J	
VR401	QVP0033-333Z	TRIM RESISTOR	33kΩ	
VR402	QVP0033-333Z	TRIM RESISTOR	33kΩ	
L431	NQL114K-470X	COIL	47uH K	
CN401	QGB1004K1-16	CONNECTOR	B-B (1-16)	
CN402	QGA2001F1-06	CONNECTOR	W-B (1-6)	
CN403	QGF1205C1-10	CONNECTOR	FFC/FPC (1-10)	
X431	QAX0414-001Z	CRYSTAL	4.19430MHz	

# Packing materials and accessories parts list

Block No. M 3 M M

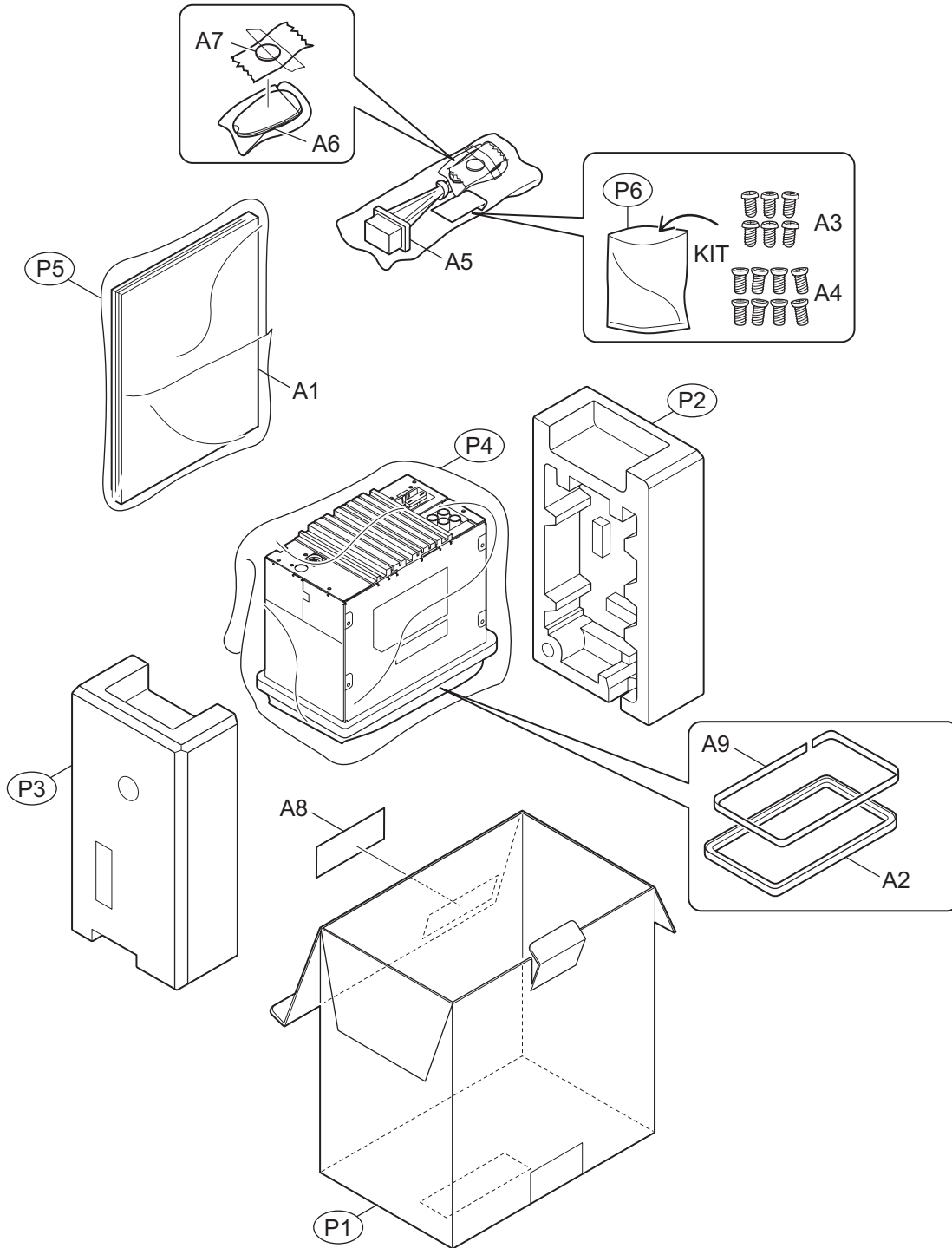

## Packing and Accessories

Block No. [M][3][M][M]

△	Symbol No.	Part No.	Part Name	Description	Local
	A 1	GET0315-001A	INST BOOK	ENG INA	
	A 2	LV21055-003A	TRIM PLATE		
	A 3	QYSDSP5008ZA	SCREW	M5 x 8mm(x6)	
	A 4	QYSSSP5008ZA	SCREW	M5 x 8mm(x8)	
	A 5	QAM0657-002	POWER CORD		
	A 6	RM-RK50C	REMOCON		
	A 7	-----	BATTERY		
	A 8	LV33728-001A	CARTON LABEL		
	A 9	LV40846-014A	SPACER(F)		
	KIT	SRW-KW410U	SCREW PARTS KIT	A3 A4	
	P 1	LV31639-003A	CARTON		
	P 2	GE10163-001A	CUSHION(L)		
	P 3	GE10164-001A	CUSHION(R)		
	P 4	QPC03004315P	POLY BAG	30cm x 43cm	
	P 5	FSPG4002-001	POLY BAG		
	P 6	QPA00801205	POLY BAG	8cm x 12cm	